

see similar files: http://130.149.60.45/~farbmetrik/ME07/ME07.HTM
technical information: http://www.ps.bam.de or http://130.149.60.45/~farbmetrik

TUB registration: 20130201-ME07/ME07LOFP.PDF /.PS
application for measurement of display output

TUB material: code=rh4ta

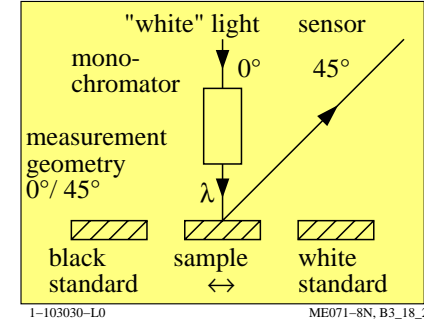
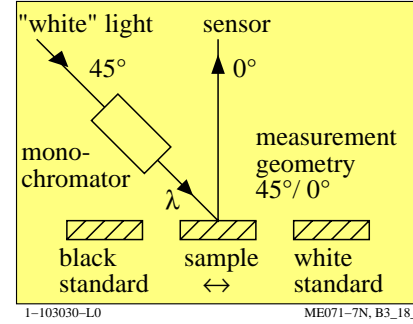
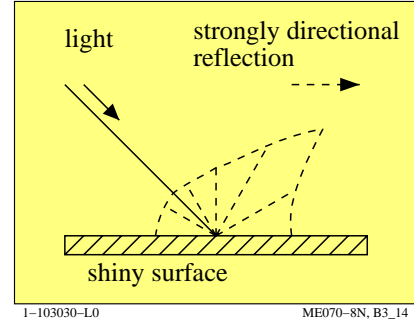
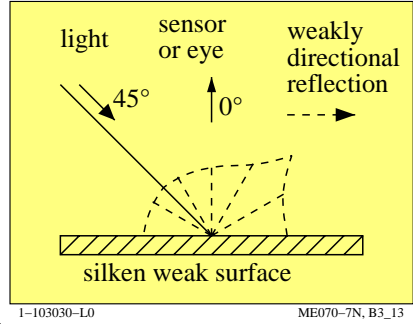
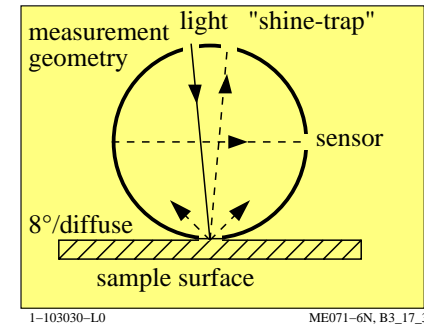
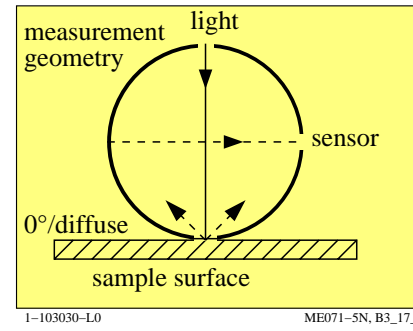
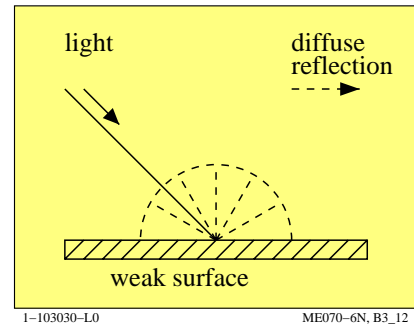
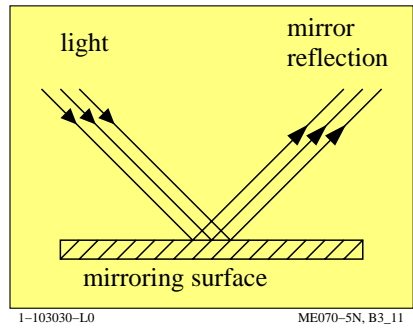
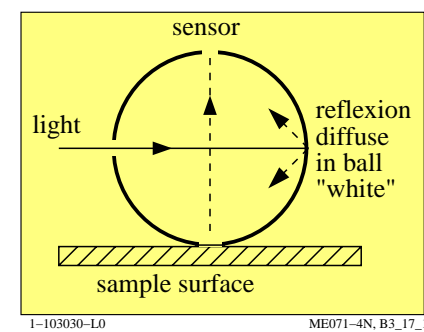
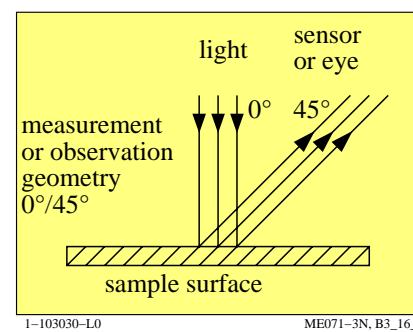
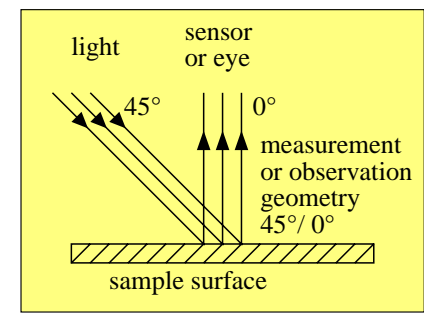
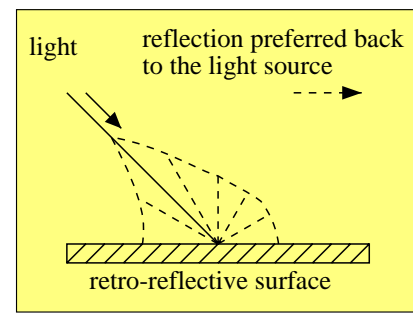
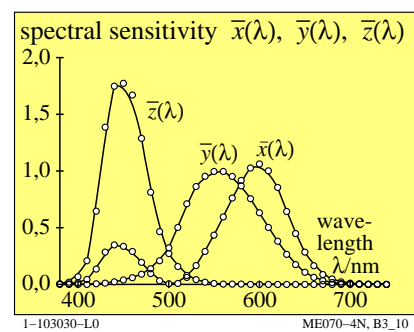
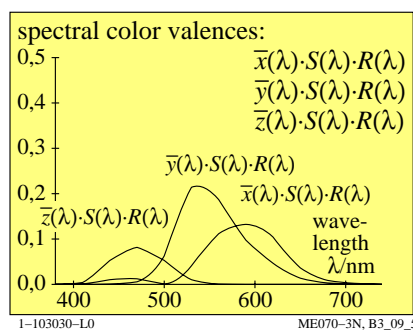
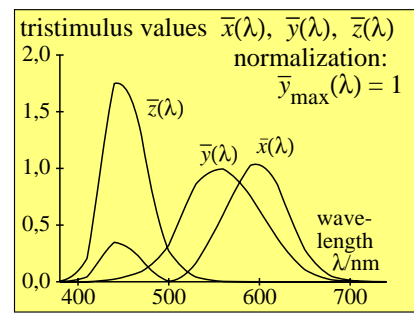
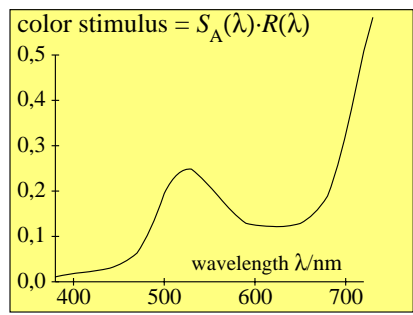

see similar files: <http://130.149.60.45/~farbmetrik/ME07/ME07LOFP.PDF> / .PS
technical information: <http://www.ps.bam.de> or <http://130.149.60.45/~farbmetrik>

TUB registration: 20130201-ME07/ME07LOFP.PDF /.PS
application for measurement of display output, no separation

TUB material: code=rh4ta

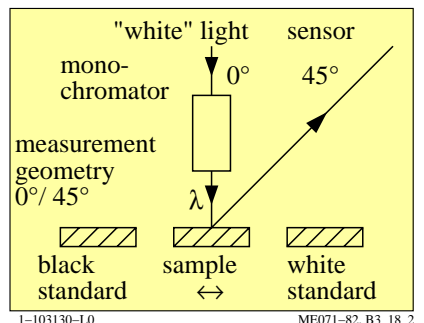
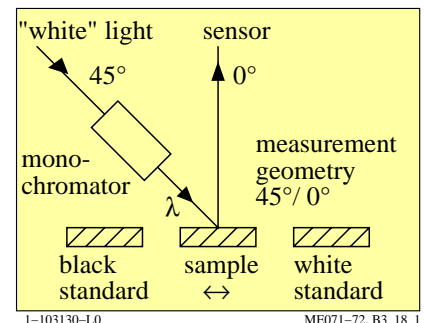
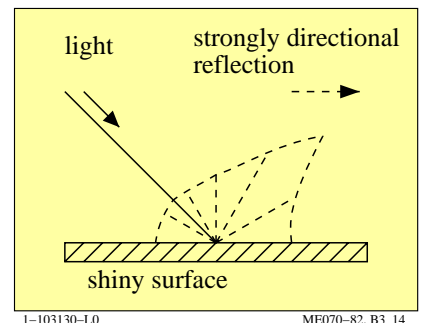
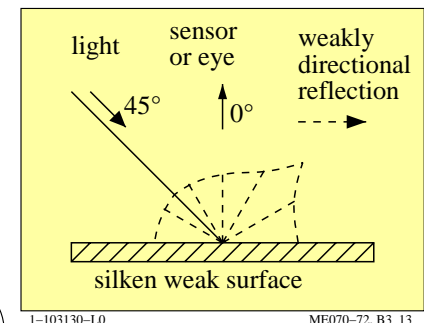
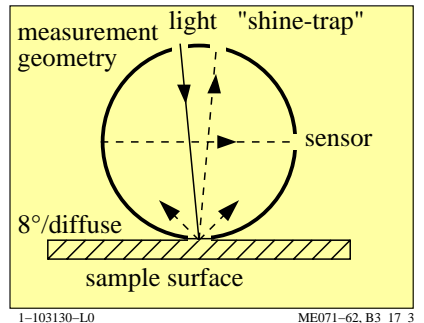
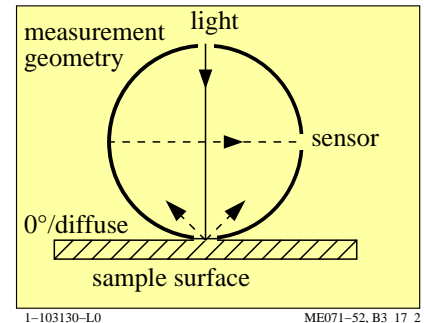
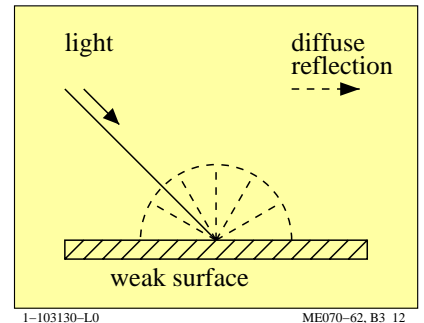
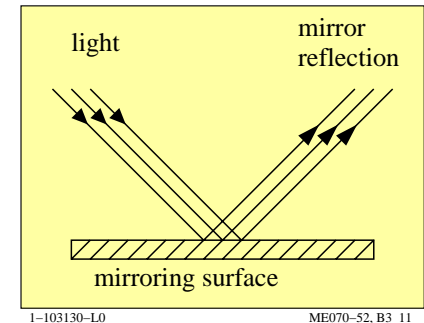
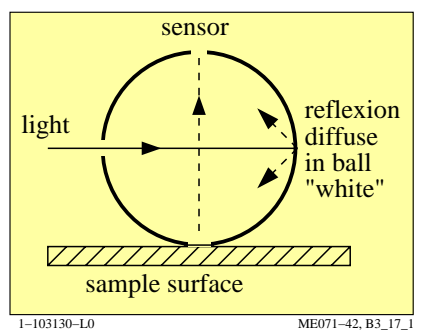
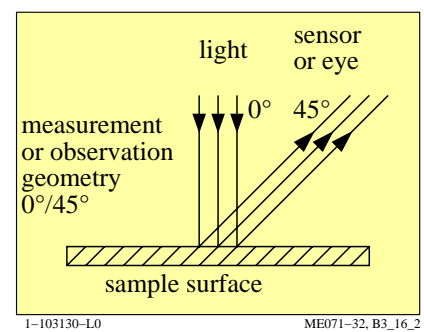
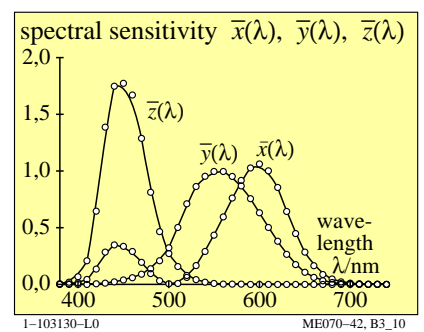
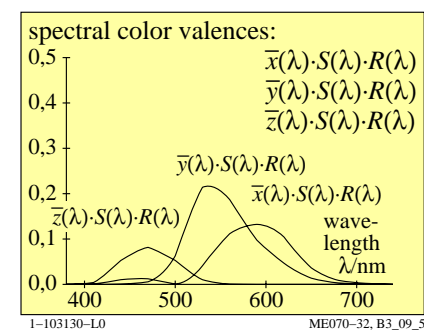
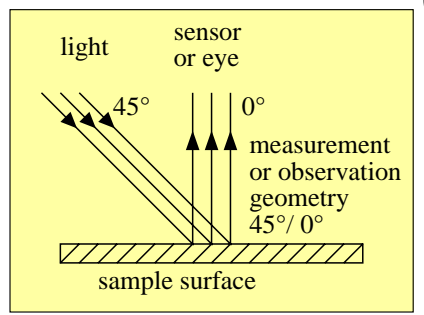
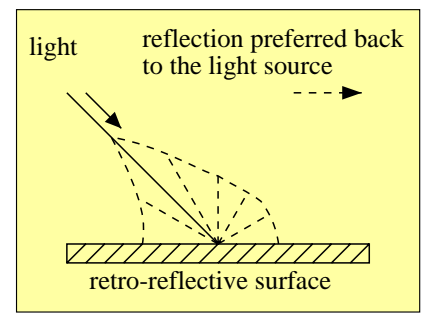
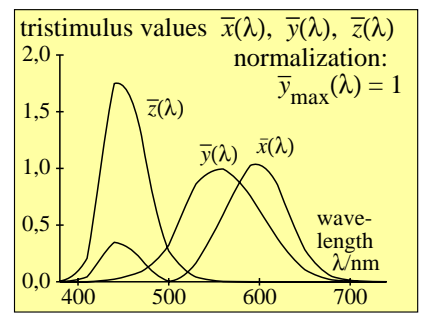
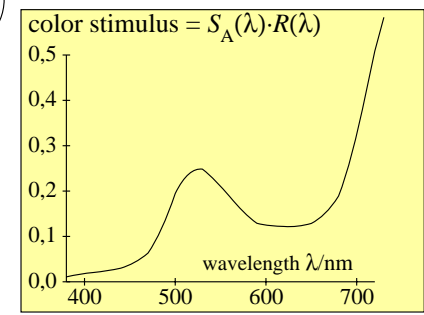
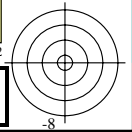

see similar files: http://130.149.60.45/~farbmetrik/ME07/ME07LOFP.PDF /.PS; start output
technical information: http://www.ps.bam.de or http://130.149.60.45/~farbmetrik

TUB registration: 20130201-ME07/ME07LOFP.PDF /.PS
application for measurement of display output

TUB material: code=rh4ta

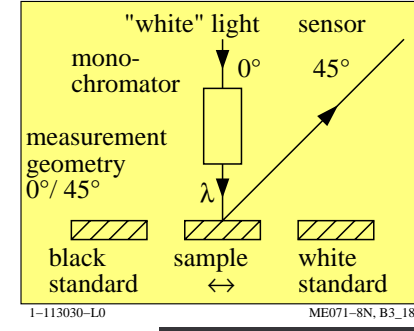
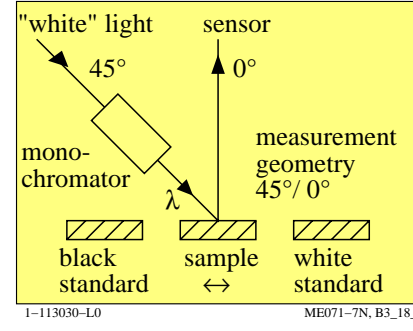
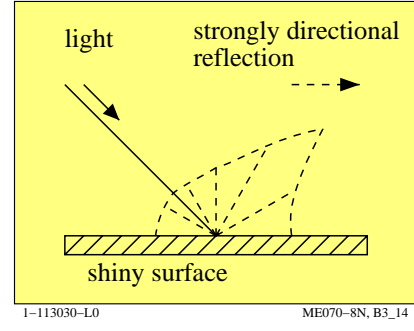
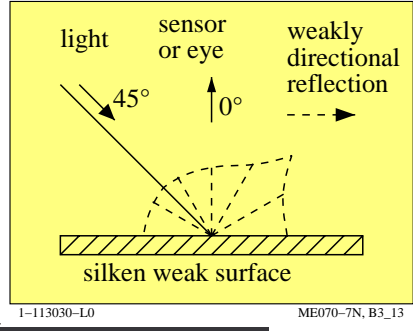
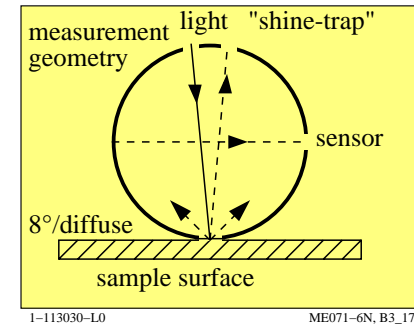
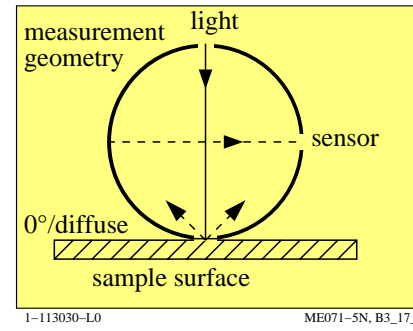
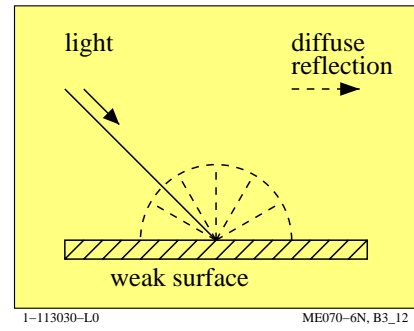
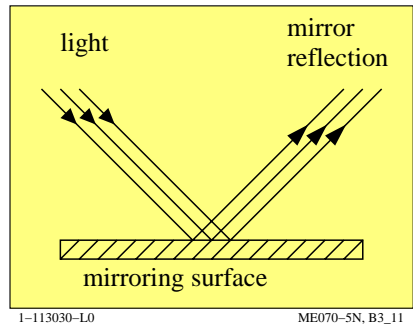
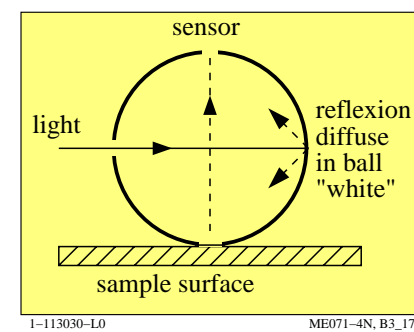
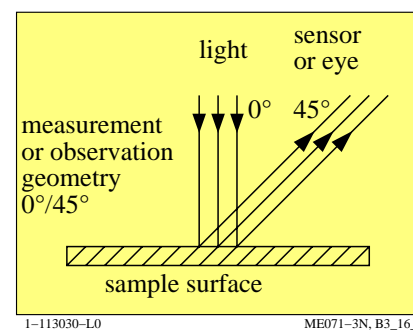
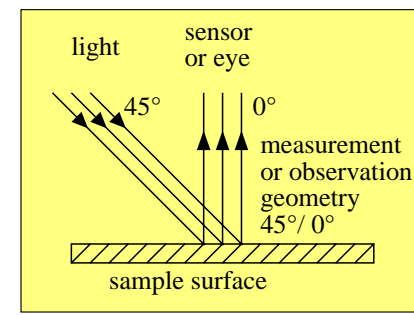
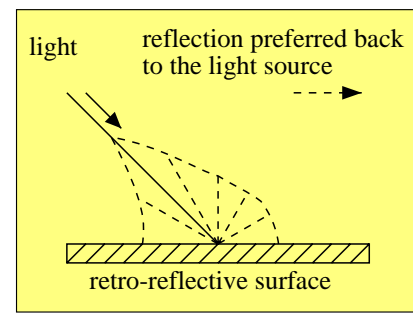
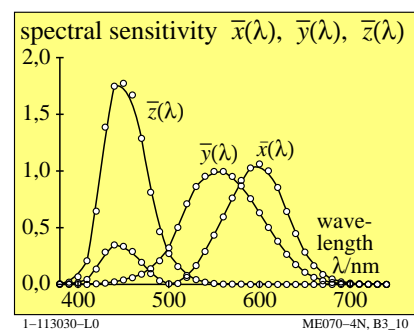
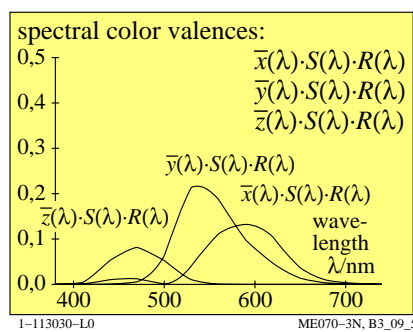
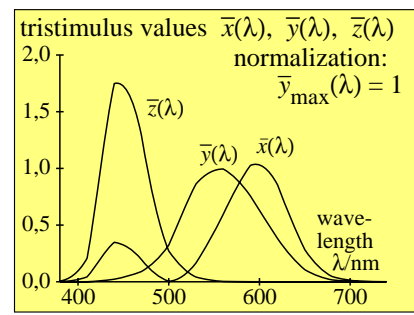
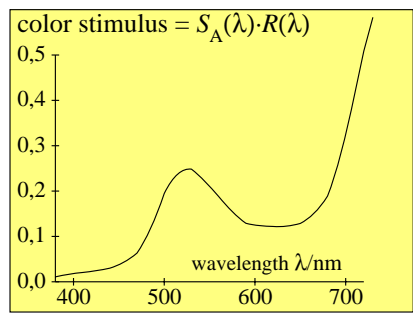

see similar files: <http://130.149.60.45/~farbmetrik/ME07/ME07LOFP.PDF> /PS
technical information: <http://www.ps.bam.de> or <http://130.149.60.45/~farbmetrik>

TUB registration: 20130201-ME07/ME07LOFP.PDF /PS
application for measurement of display output, no separation

TUB material: code=rh4ta

