

vedi file simili: http://farbe.li.tu-berlin.de/MI07/MI07.HTM
http://130.149.60.45/~farbmertik o http://farbe.li.tu-berlin.de

iscrizione TUB: 20160501-MI07/MI07L0NP.PDF /PS
Applicazione per la misura dell'output su display

TUB materiale: code=rh4ta

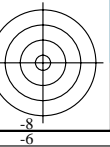
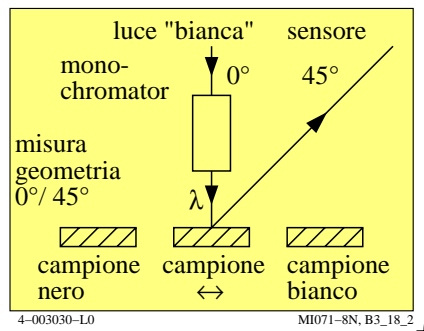
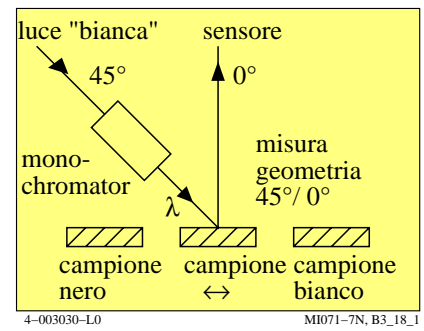
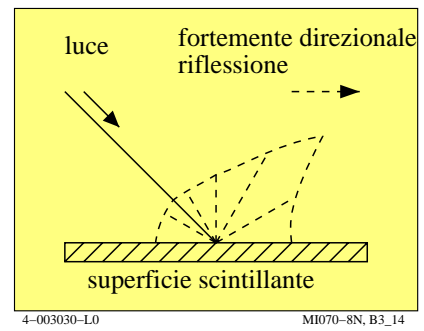
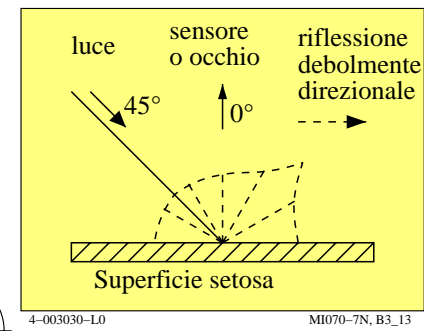
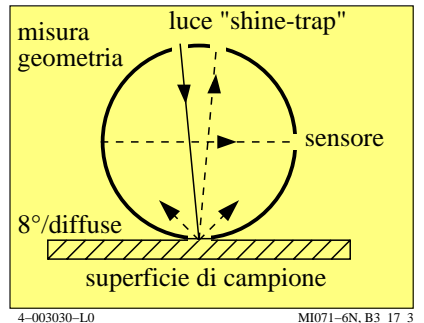
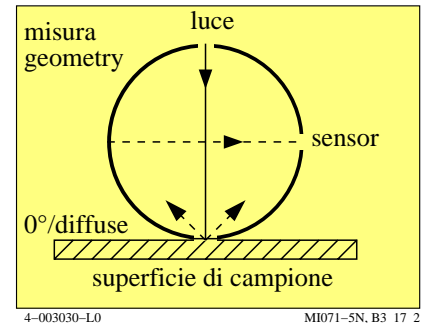
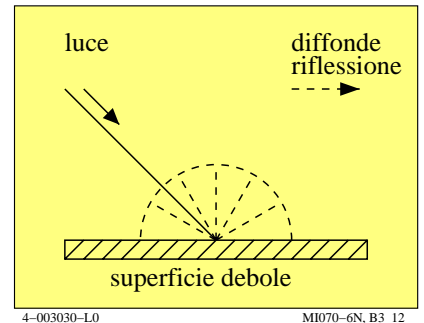
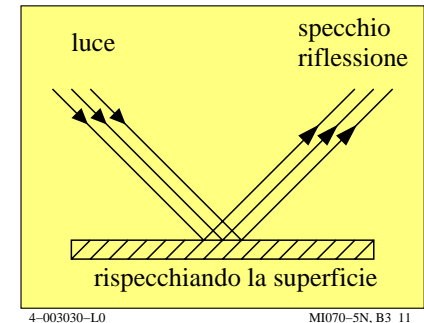
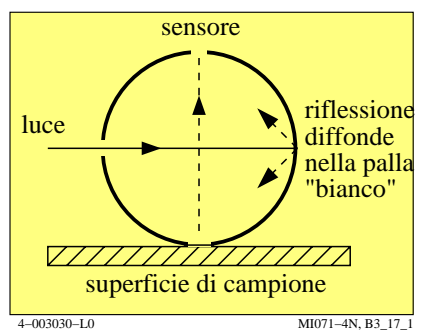
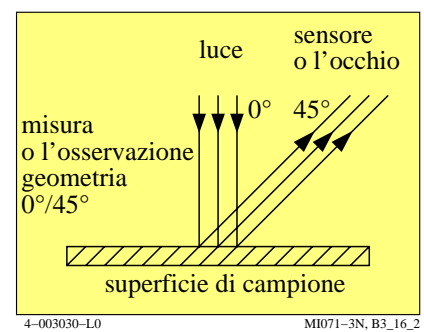
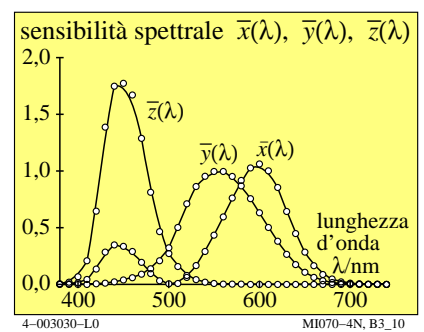
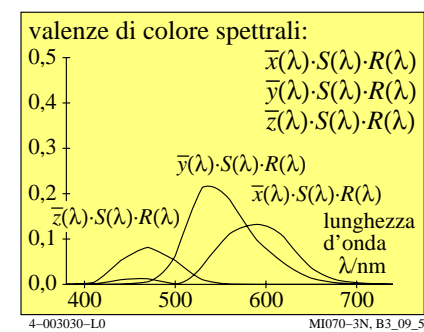
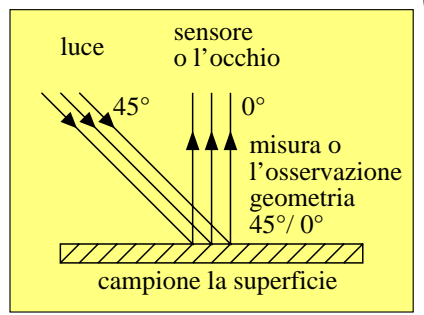
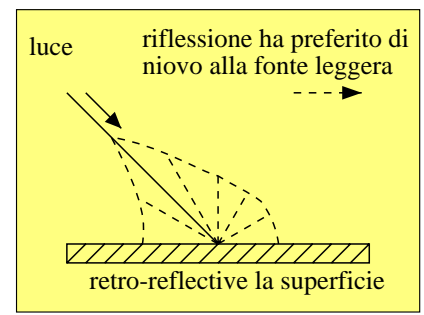
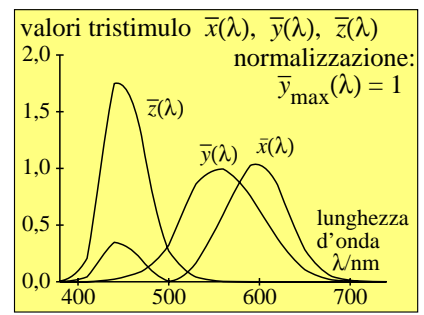
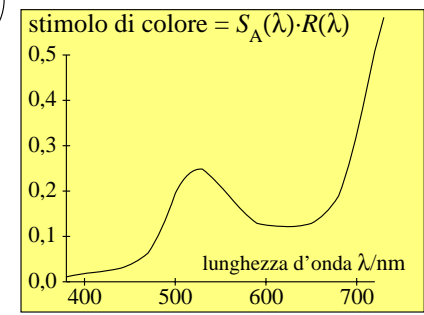
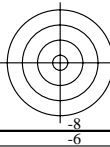

vedi file simili: http://farbe.li.tu-berlin.de/MI07/MI07.HTM
http://130.149.60.45/~farbmertik o http://farbe.li.tu-berlin.de

iscrizione TUB: 20160501-MI07/MI07L0NP.PDF /PS
Applicazione per la misura dell'output su display, nessuna separazione

TUB materiale: code=rh4ta

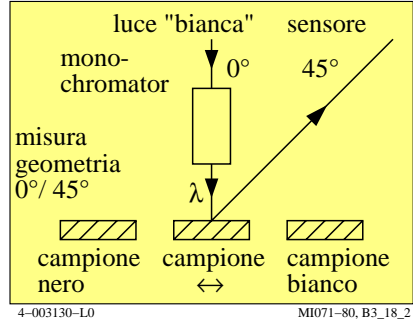
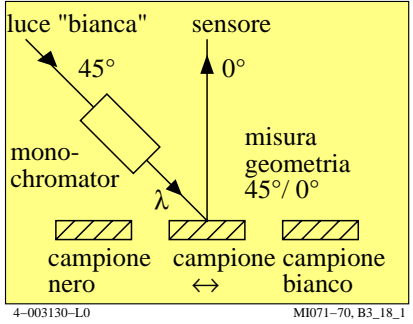
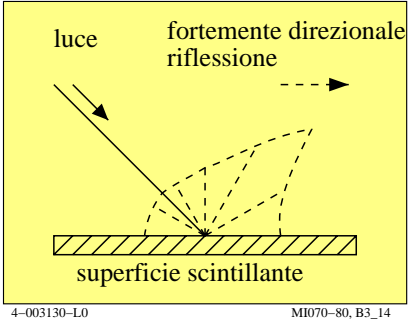
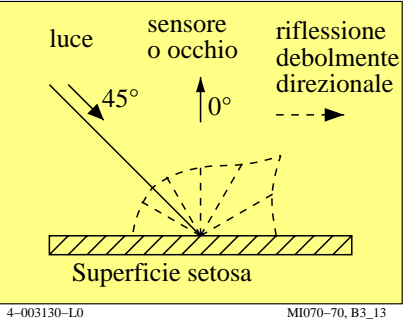
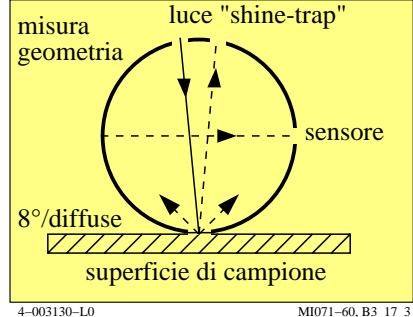
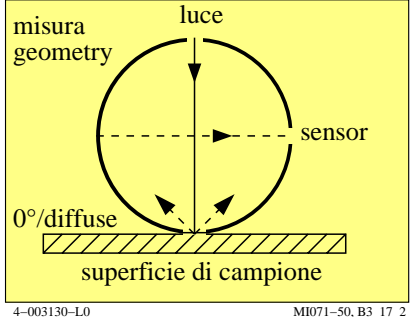
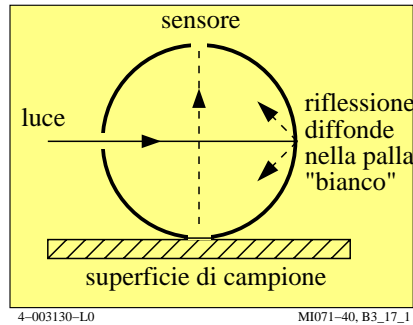
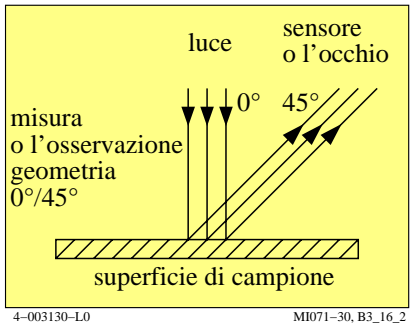
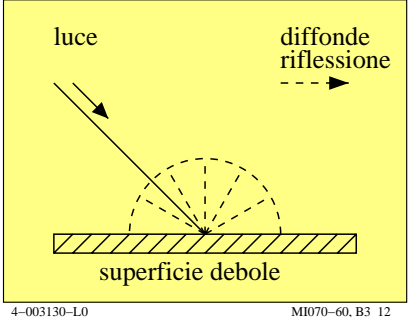
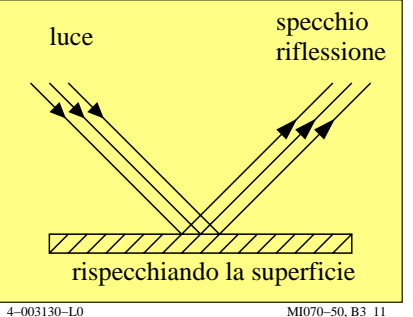
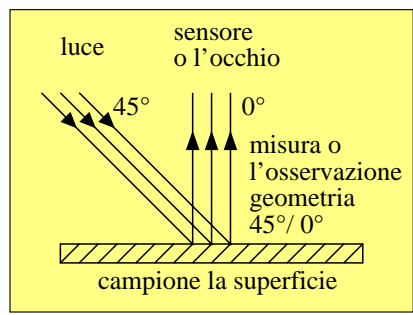
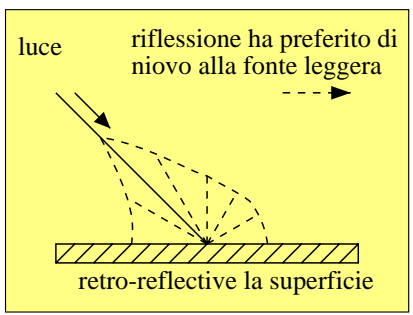
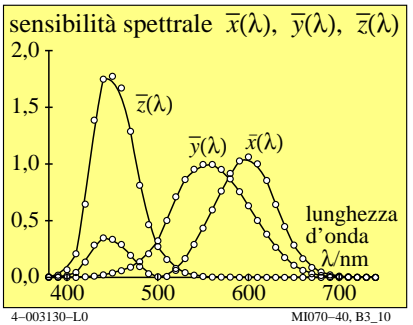
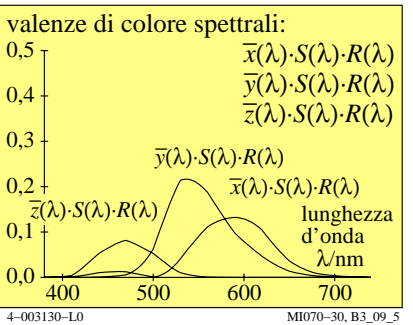
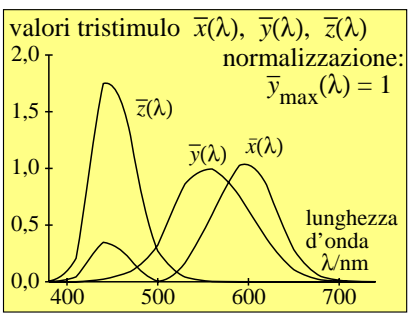
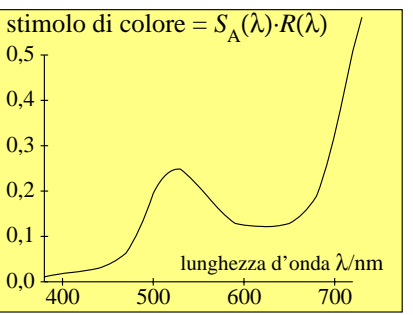

vedi file simili: http://farbe.li.tu-berlin.de/MI07/MI07.HTM
http://130.149.60.45/~farbmertik o http://farbe.li.tu-berlin.de

iscrizione TUB: 20160501-MI07/MI07L0NP.PDF /PS
Applicazione per la misura dell'output su display

TUB materiale: code=rh4ta

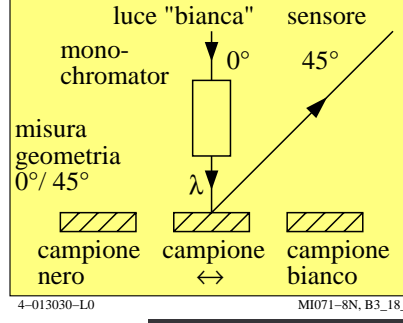
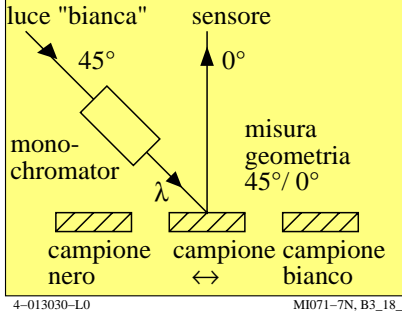
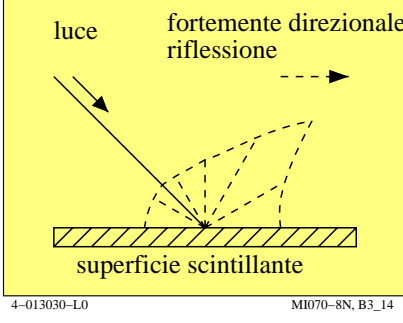
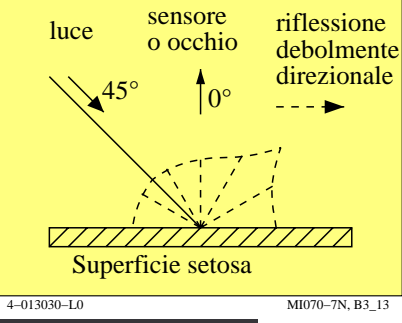
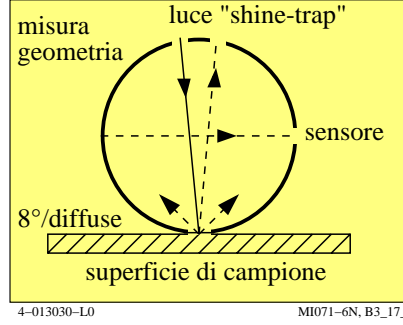
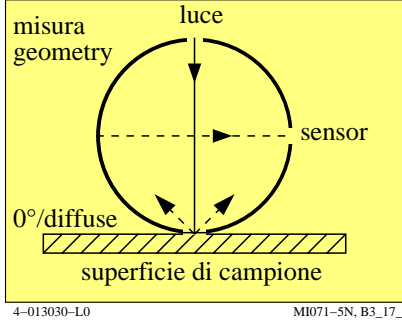
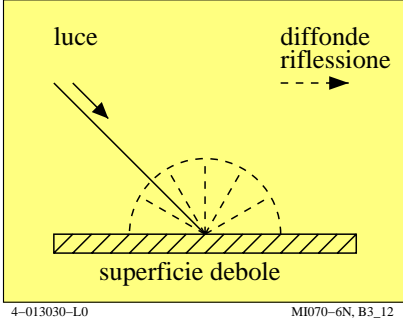
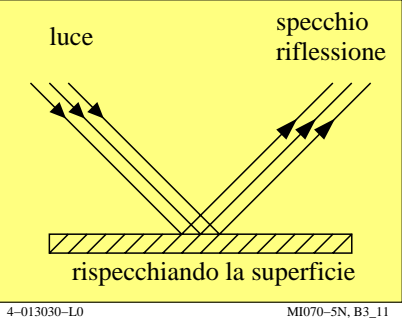
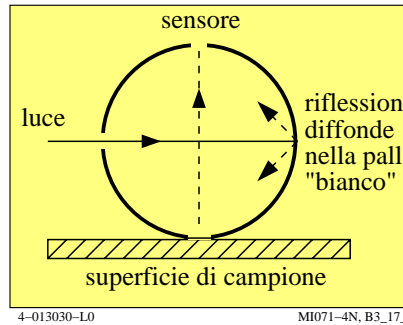
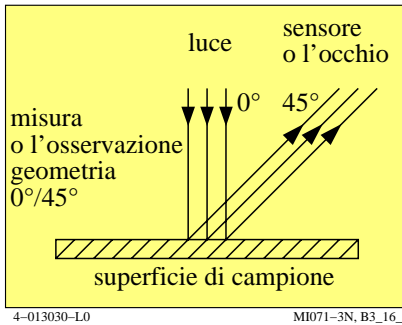
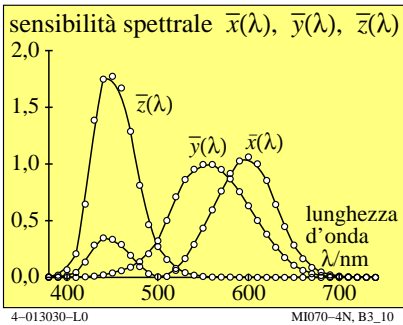
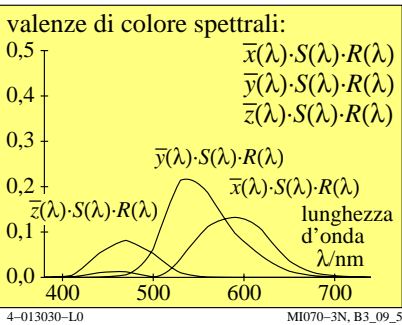
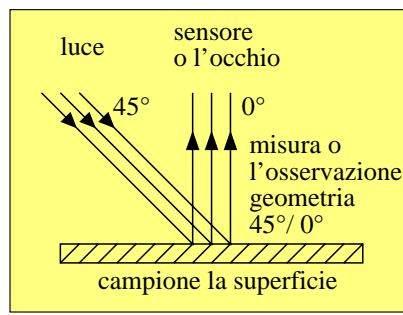
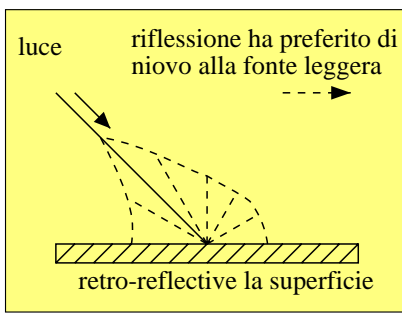
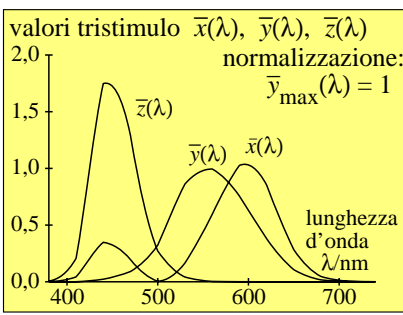
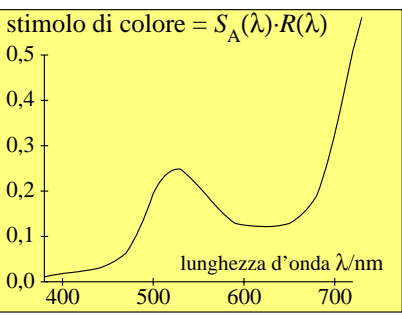
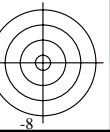

vedi file simili: http://farbe.li.tu-berlin.de/MI07/MI07.HTM
http://130.149.60.45/~farbmertik o http://farbe.li.tu-berlin.de

iscrizione TUB: 20160501-MI07/MI07L0NP.PDF /PS
Applicazione per la misura dell'output su display, nessuna separazione
TUB materiale: code=rh4ta

