

se lignende filer: http://farbe.li.tu-berlin.de/MN57/MN57.HTM  
http://130.149.60.45/~farbmetrik eller http://farbe.li.tu-berlin.de

TUB registrering: 20190801-MN57/MN57L0FP.PDF /.PS  
anvendelse for måling av display output

TUB materiell: code=rh4da

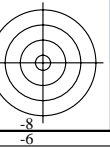
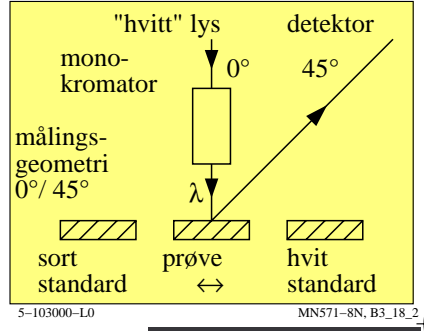
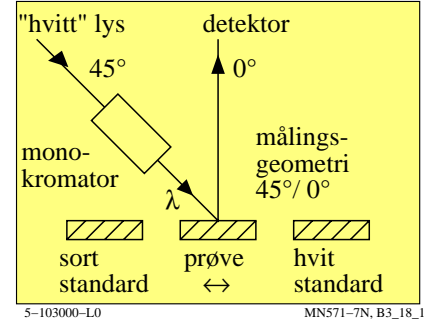
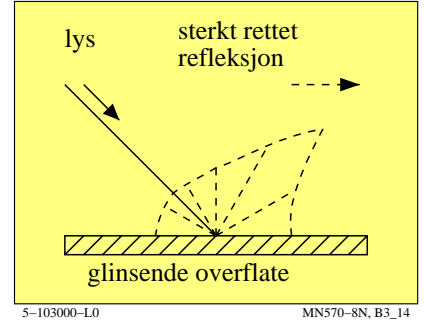
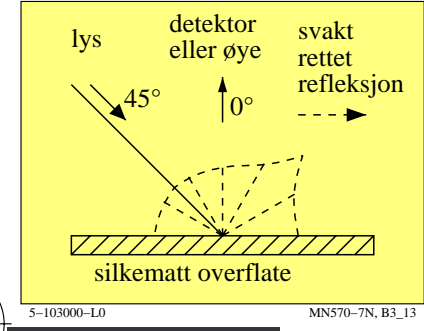
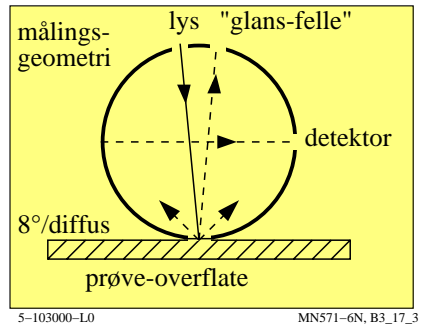
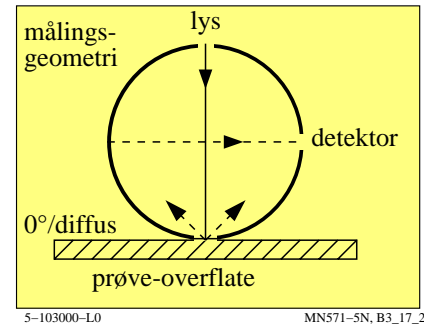
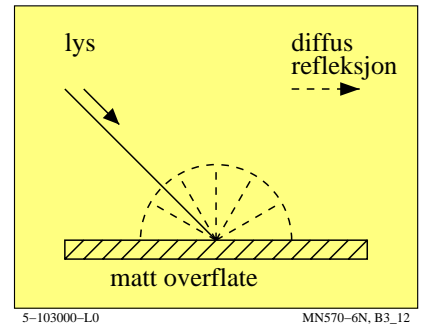
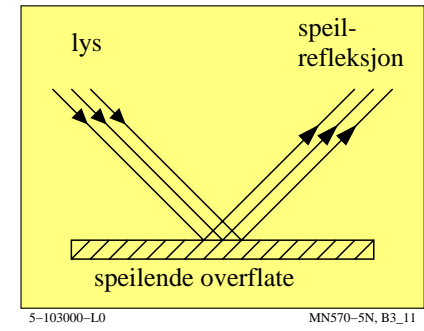
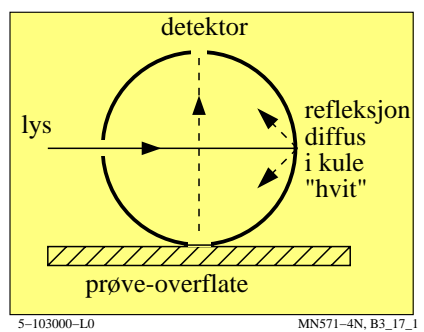
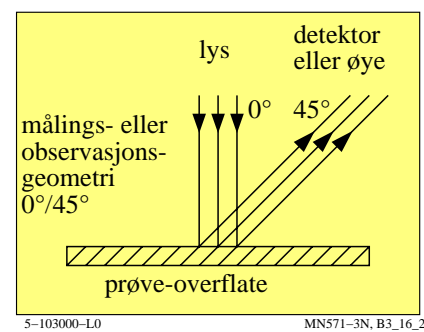
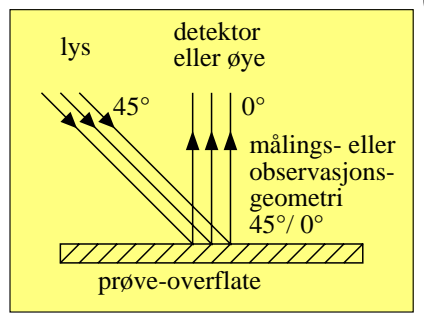
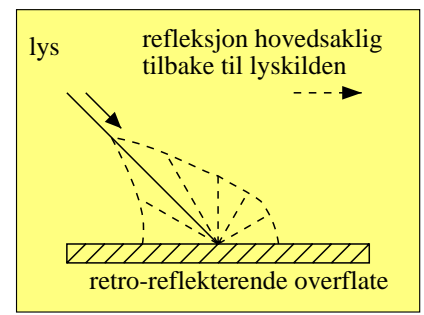
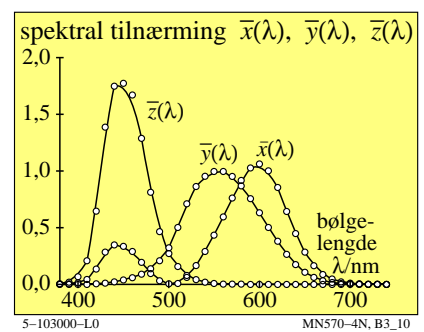
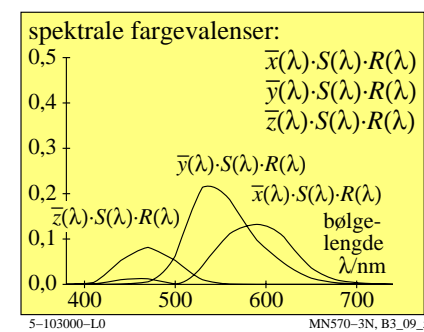
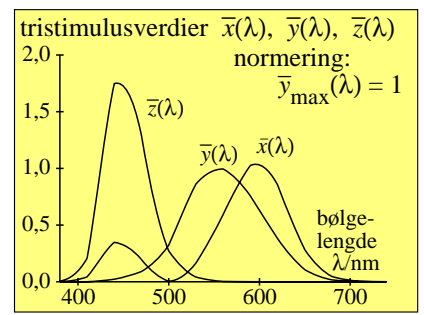
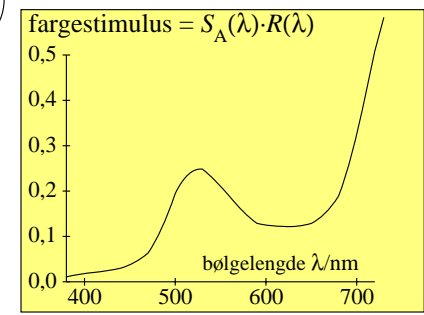
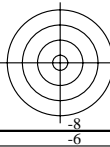

se lignende filer: http://farbe.li.tu-berlin.de/MN57/MN57.HTM  
http://130.149.60.45/~farbmetrik eller http://farbe.li.tu-berlin.de

TUB registrering: 20190801-MN57/MN57L0FP.PDF /.PS  
anvendelse for måling av display output, ingen separasjon

TUB materiell: code=rh4da

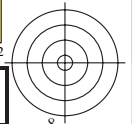
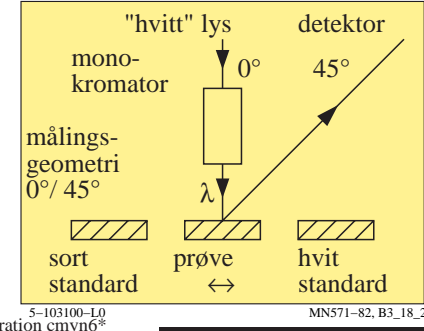
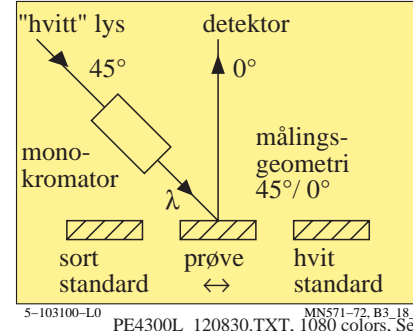
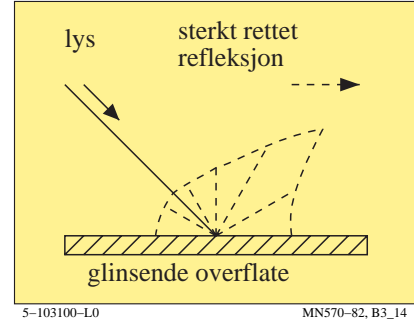
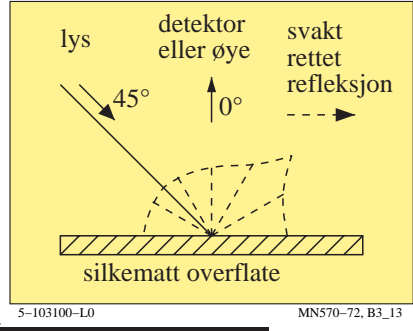
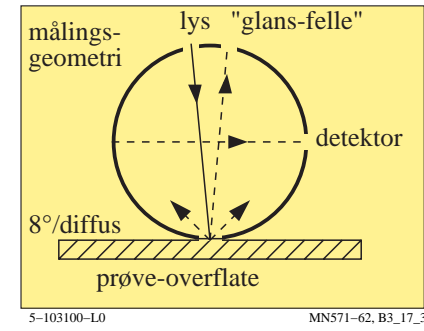
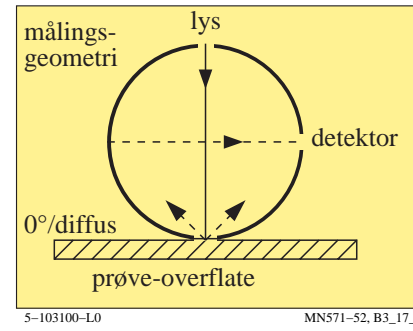
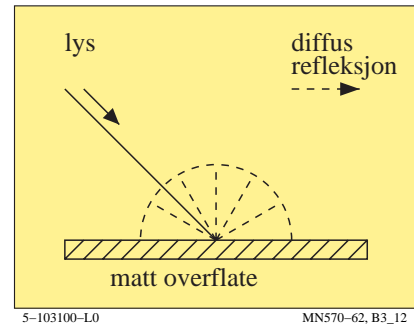
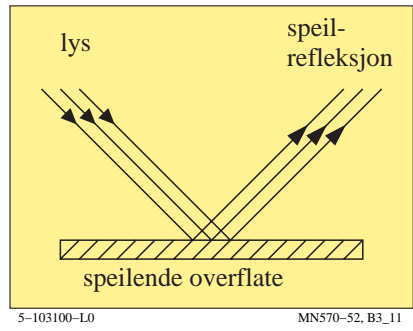
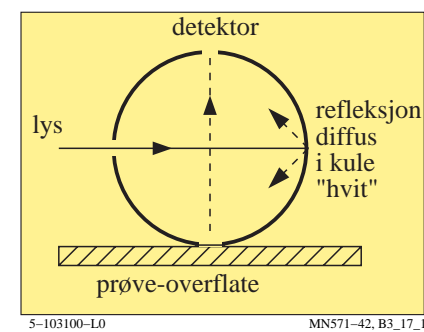
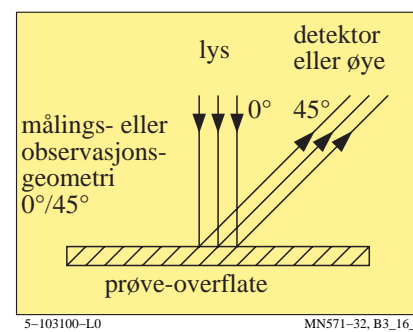
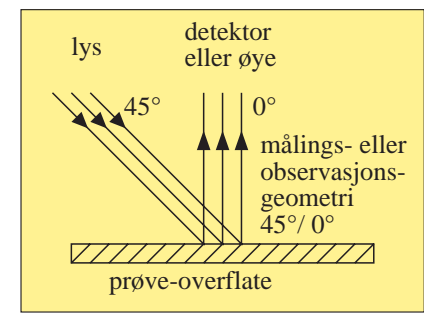
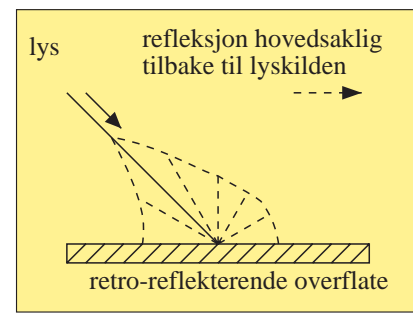
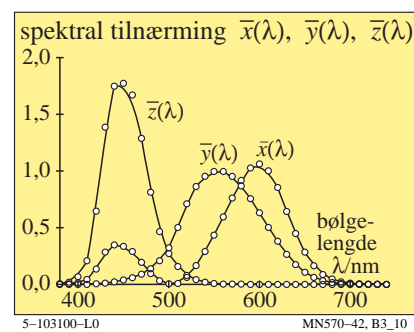
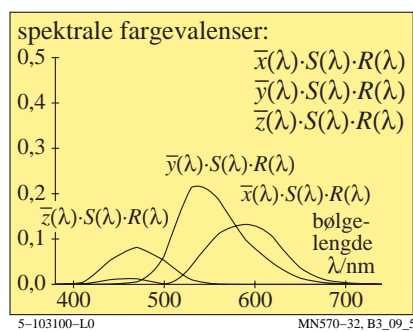
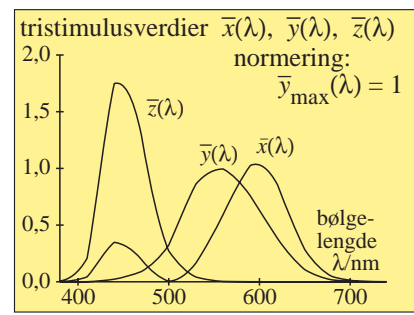
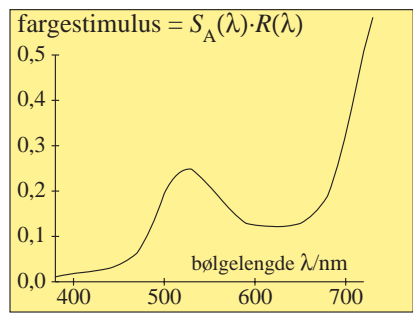

se lignende filer: http://farbe.li.tu-berlin.de/MN57/MN57.HTM  
http://130.149.60.45/~farbmetrik eller http://farbe.li.tu-berlin.de

TUB registrering: 20190801-MN57/MN57L0FP.PDF /.PS  
anvendelse for måling av display output

TUB materiell: code=rh4da

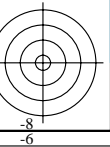
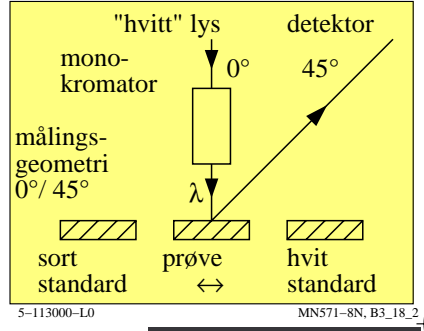
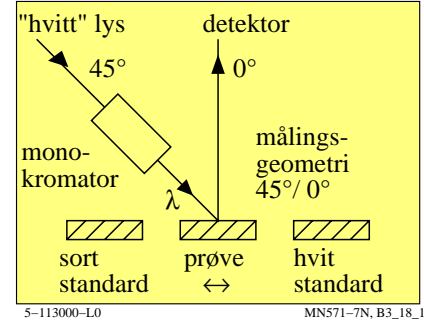
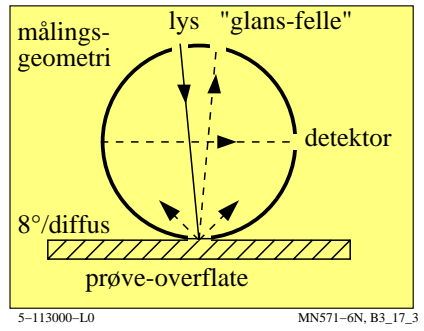
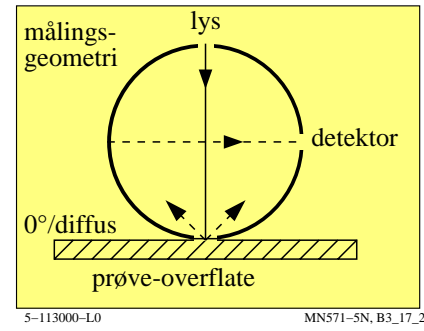
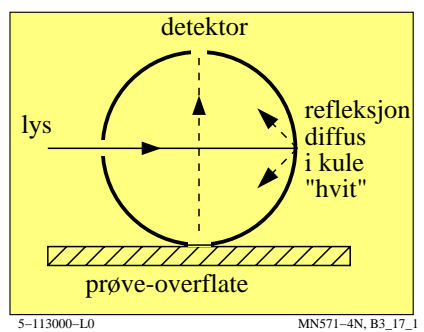
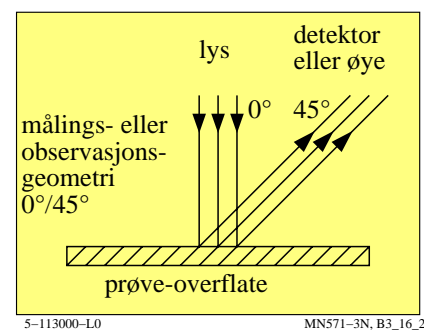
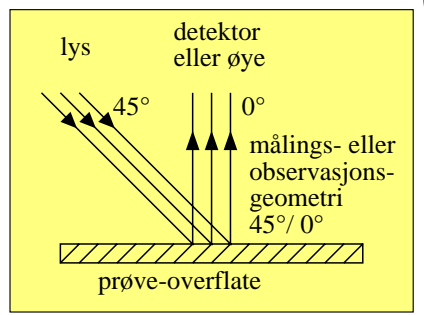
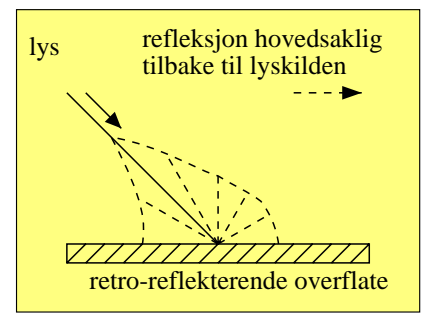
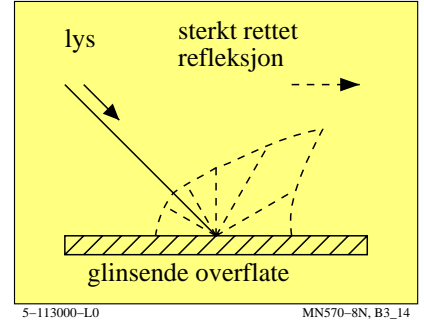
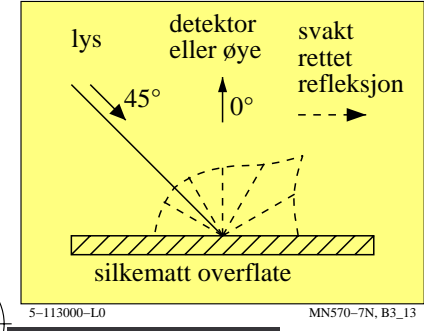
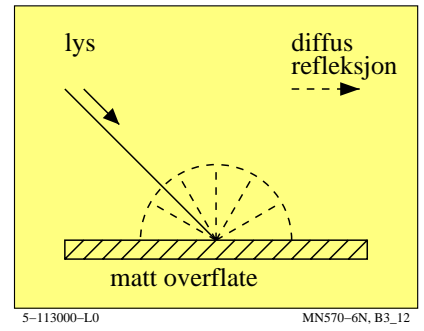
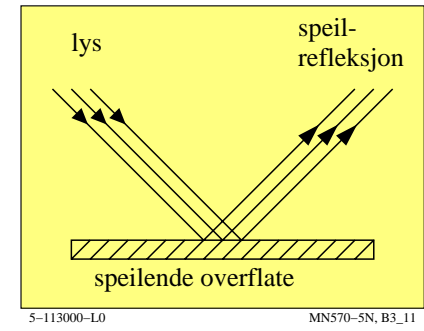
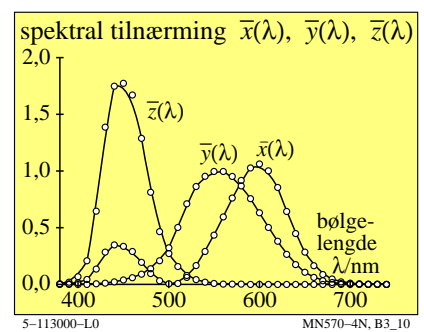
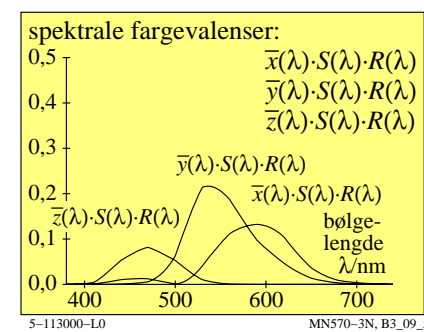
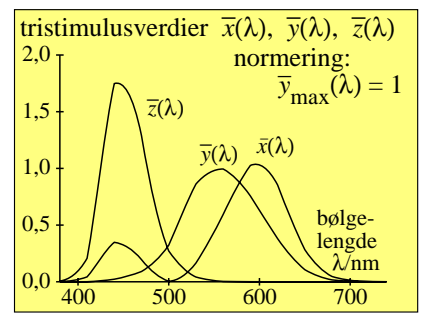
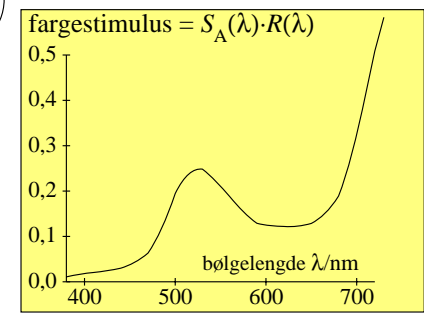
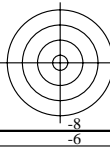

se lignende filer: http://farbe.li.tu-berlin.de/MN57/MN57.HTM  
http://130.149.60.45/~farbmetrik eller http://farbe.li.tu-berlin.de

TUB registrering: 20190801-MN57/MN57L0FP.PDF /.PS  
anvendelse for måling av display output, ingen separasjon

TUB materiell: code=rh4ta

