

se lignende filer: http://farbe.li.tu-berlin.de/MN57/MN57.HTM
http://130.149.60.45/~farbmetrik eller http://farbe.li.tu-berlin.de

TUB registrering: 20190801-MN57/MN57L0NA.TXT /.PS
anvendelse for måling av display output

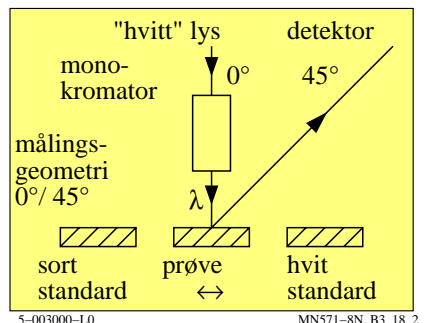
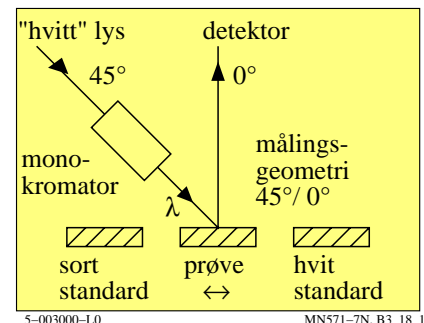
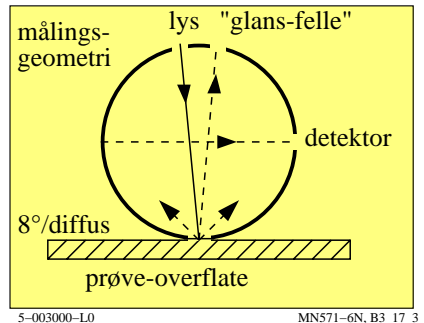
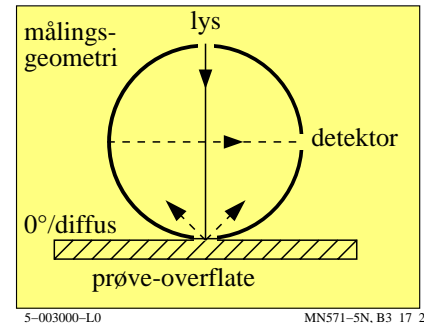
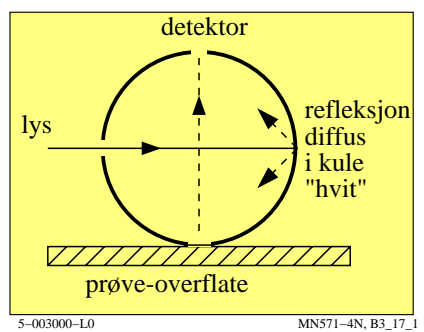
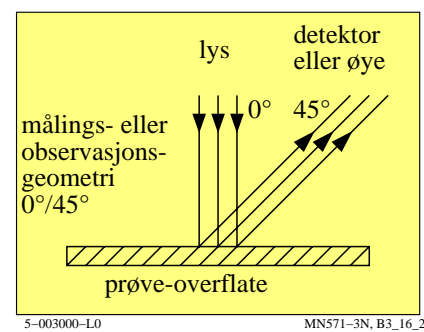
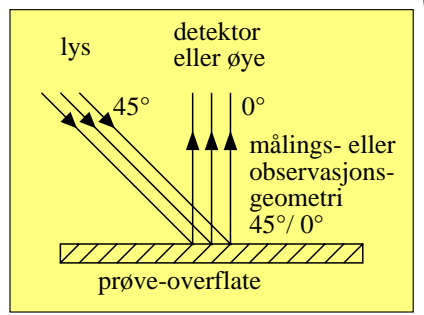
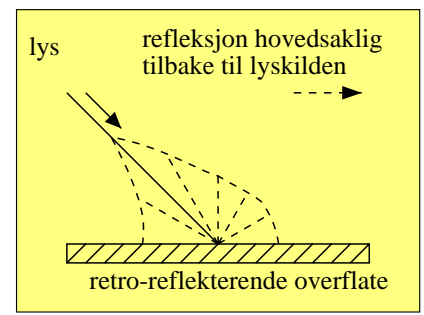
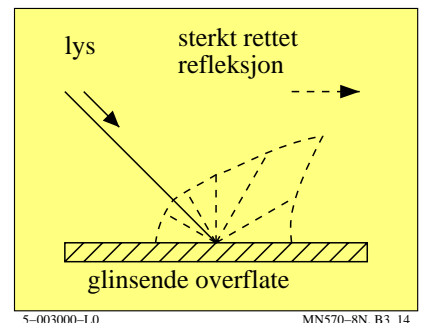
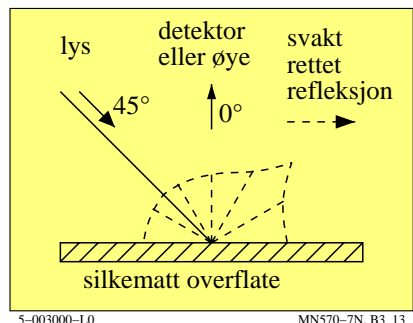
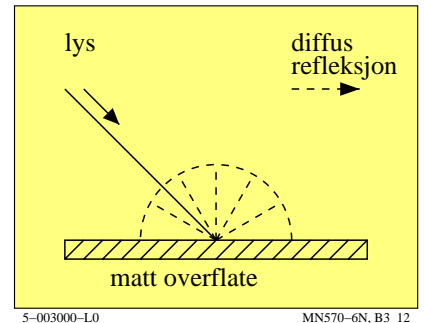
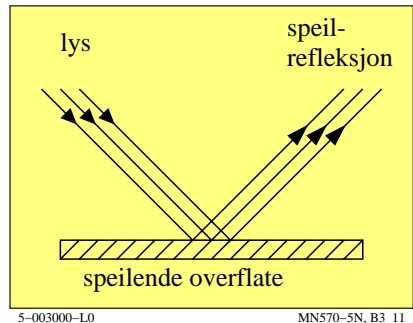
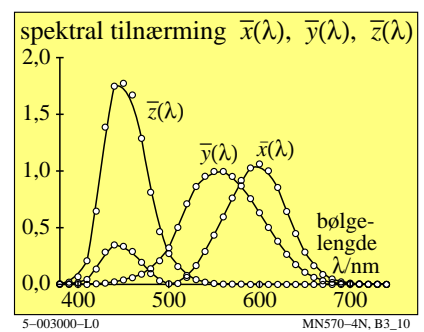
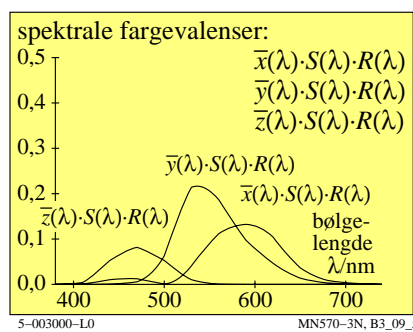
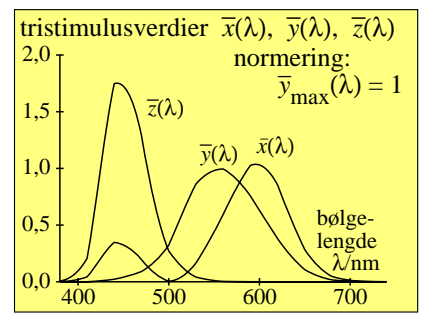
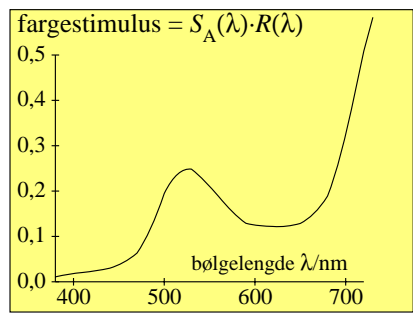
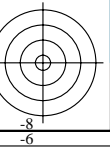

se lignende filer: http://farbe.li.tu-berlin.de/MN57/MN57.HTM
http://130.149.60.45/~farbmetrik eller http://farbe.li.tu-berlin.de

TUB registrering: 20190801-MN57/MN57L0NA.TXT /.PS
anvendelse for måling av display output, ingen separasjon

TUB materiell: code=rh4da

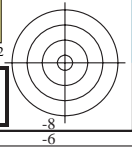
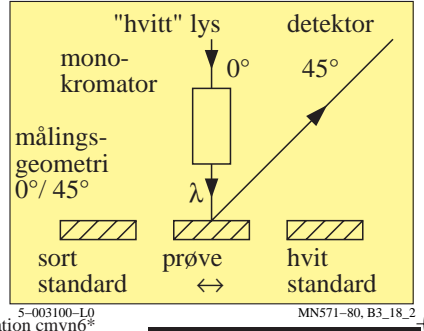
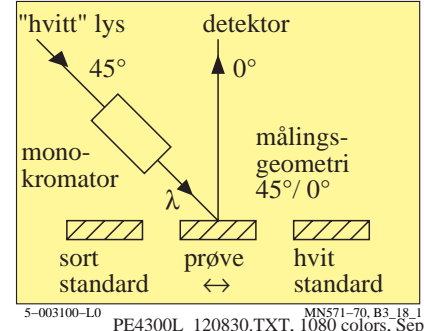
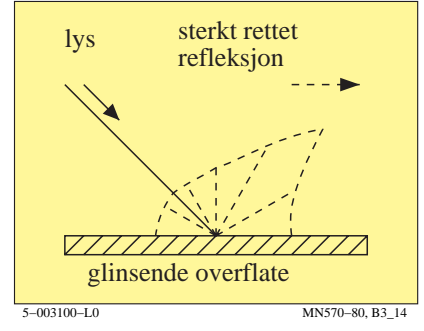
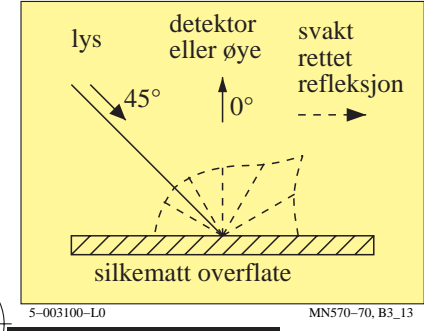
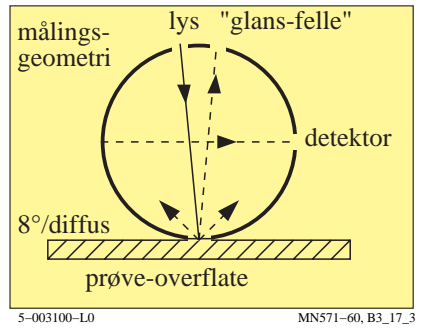
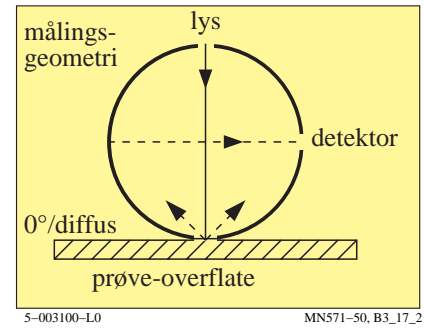
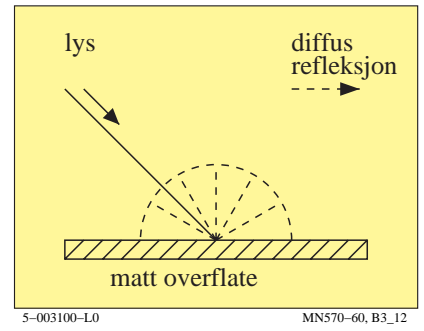
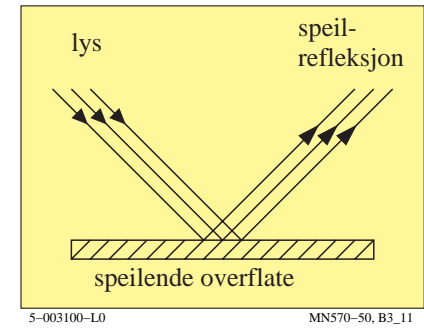
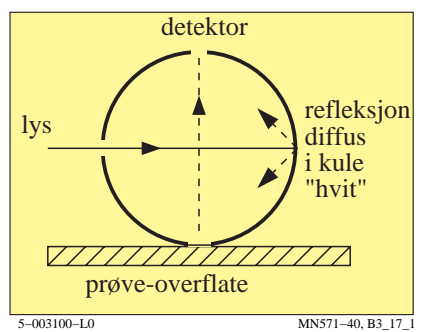
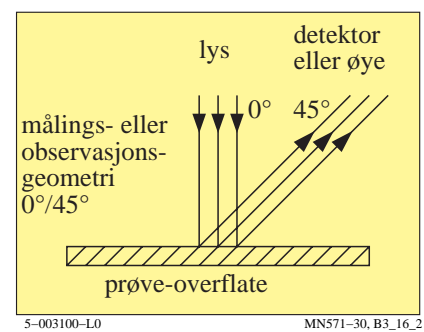
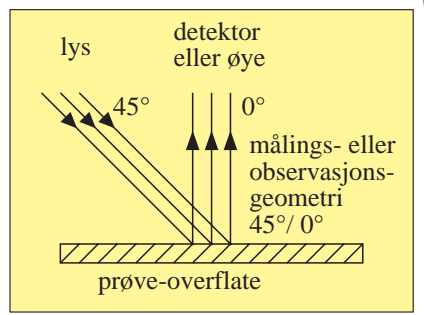
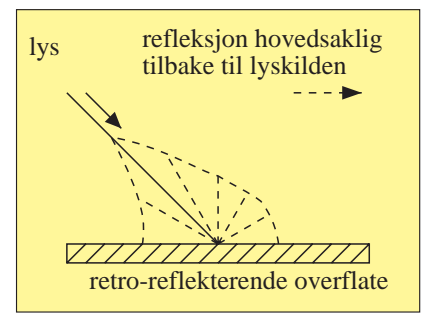
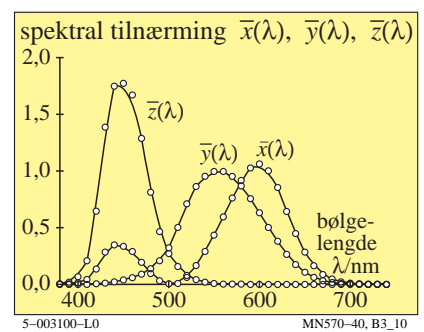
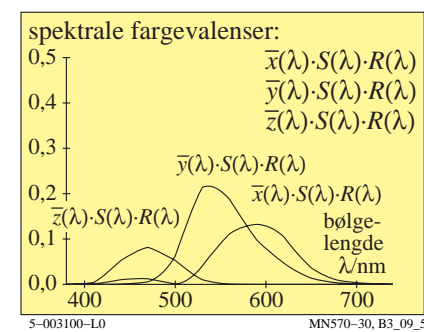
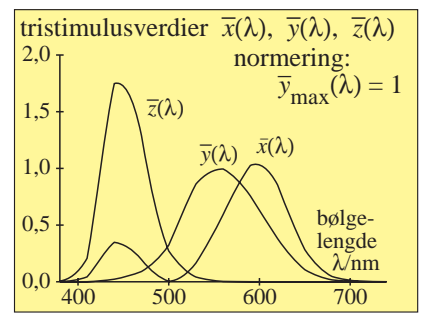
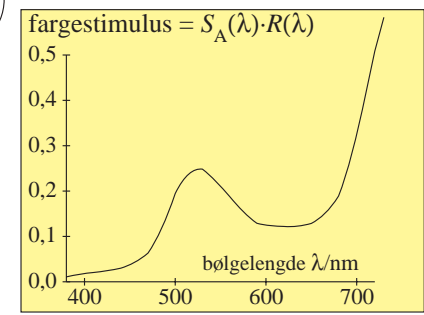
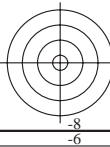

se lignende filer: http://farbe.li.tu-berlin.de/MN57/MN57.HTM
http://130.149.60.45/~farbmetrik eller http://farbe.li.tu-berlin.de

TUB registrering: 20190801-MN57/MN57L0NA.TXT /.PS
anvendelse for måling av display output

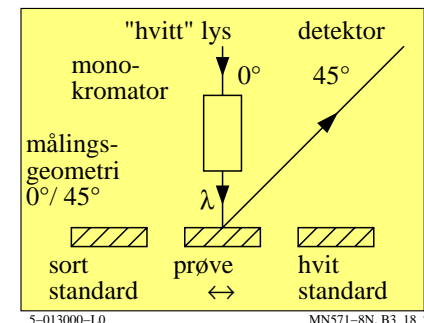
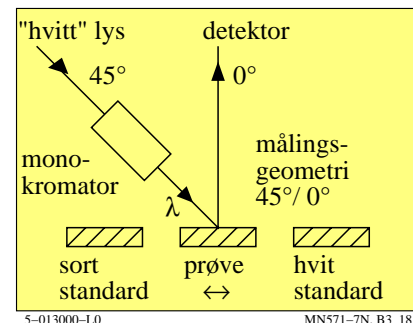
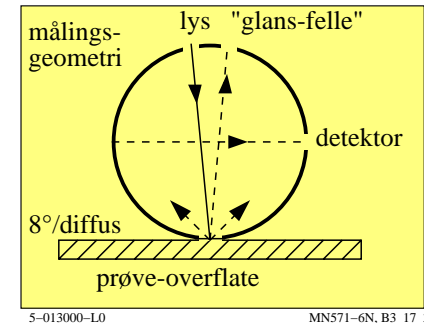
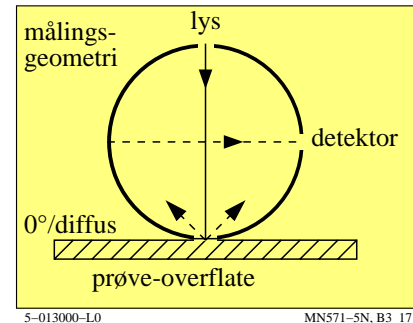
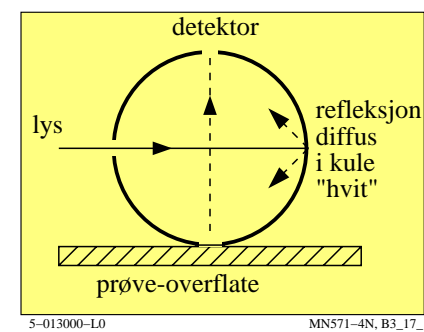
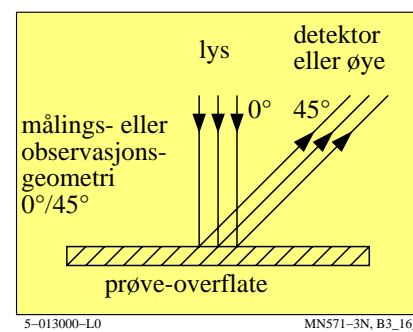
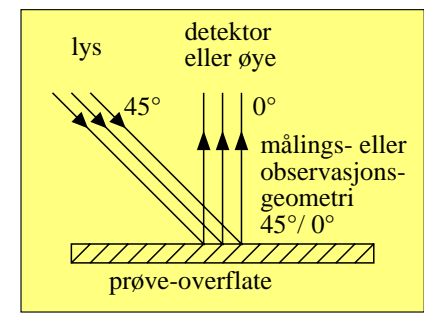
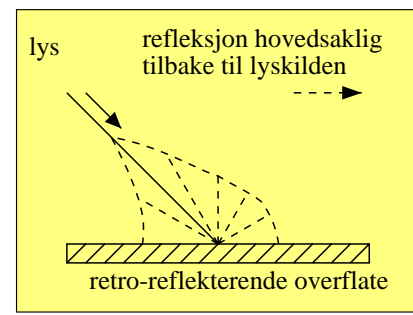
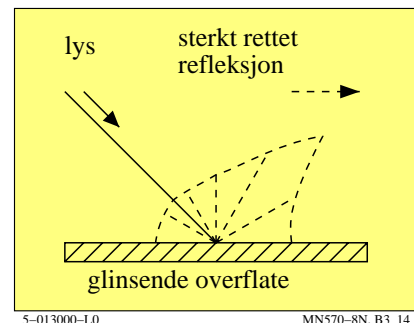
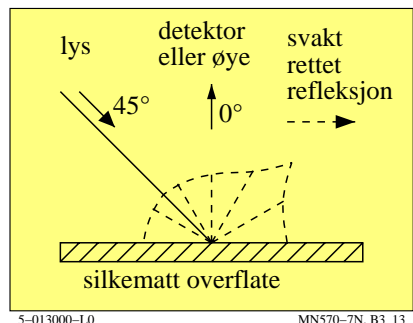
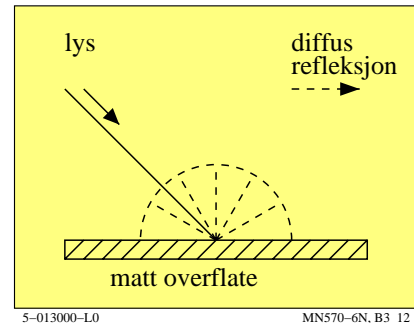
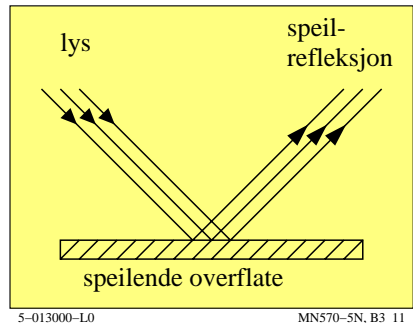
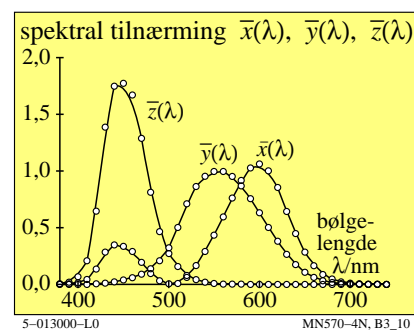
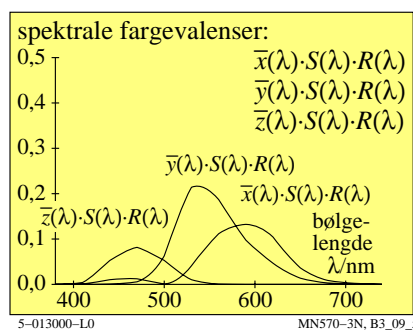
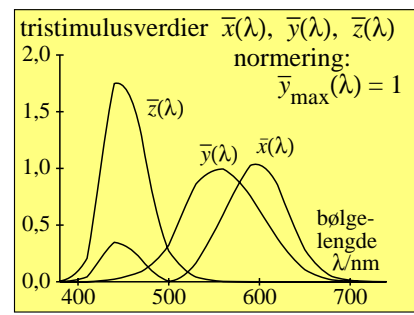
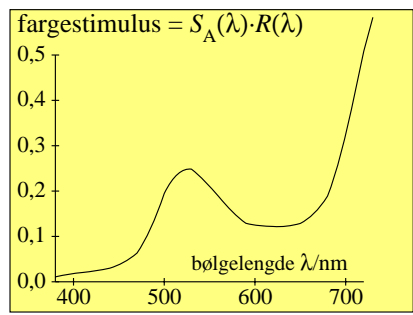

se lignende filer: http://farbe.li.tu-berlin.de/MN57/MN57.HTM
http://130.149.60.45/~farbmetrik eller http://farbe.li.tu-berlin.de

TUB registrering: 20190801-MN57/MN57L0NA.TXT /.PS
anvendelse for måling av display output, ingen separasjon

TUB materiell: code=rh4da

