

vea archivos semejantes: http://130.149.60.45/~farbmetrik/MS07/MS07.HTM
información técnica: http://www.ps.bam.de o http://130.149.60.45/~farbmetrik

TUB matrícula: 20130201-MS07/MS07LONP.PDF /.PS
aplicación para la medida de display output

TUB material: code=rh4ta

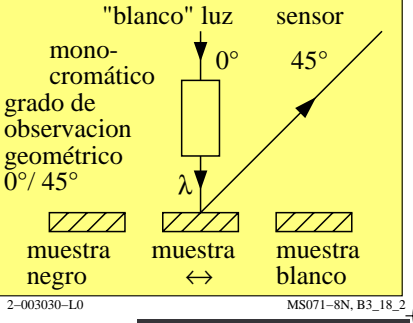
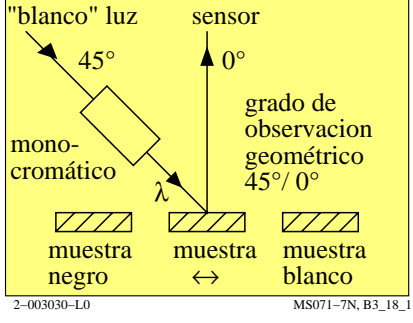
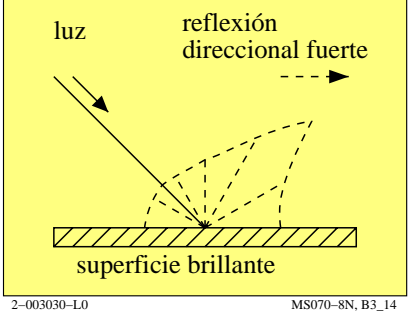
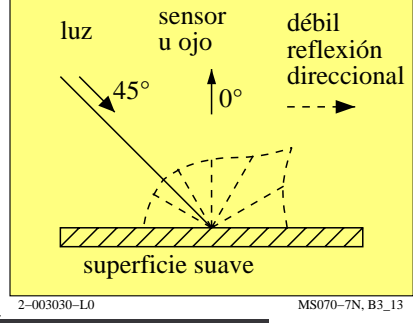
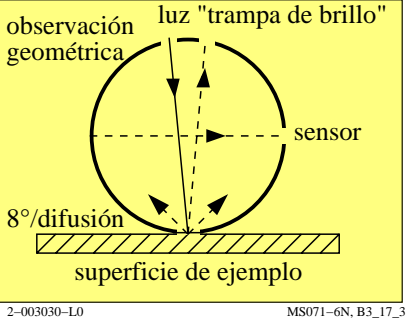
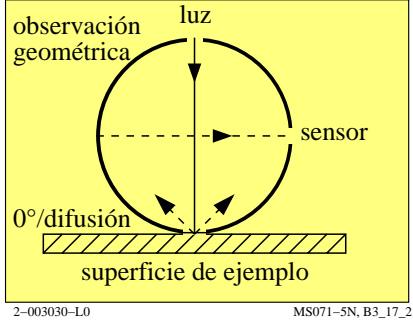
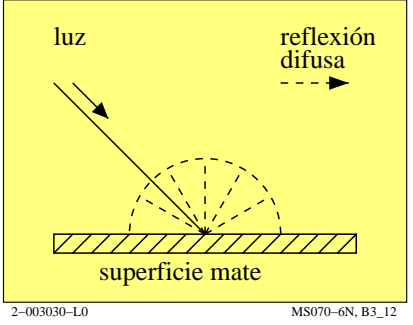
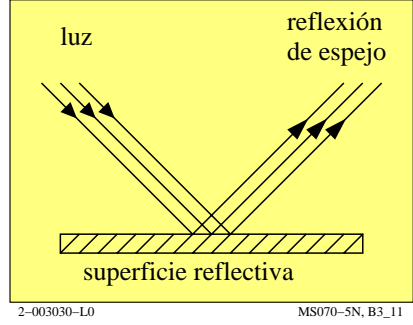
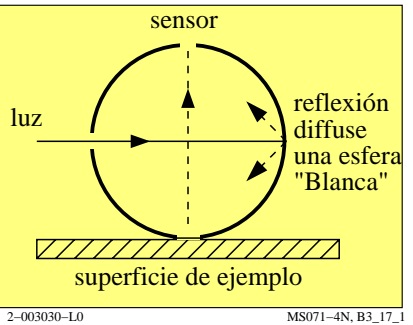
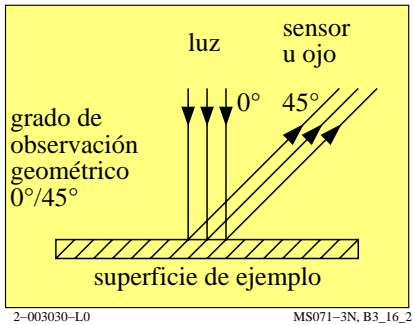
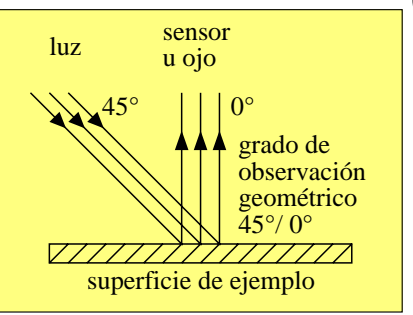
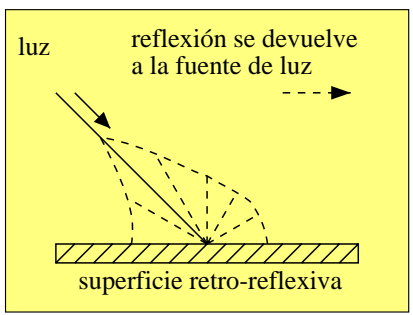
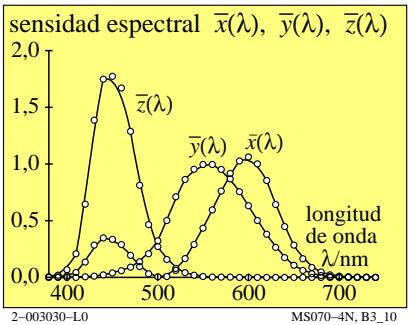
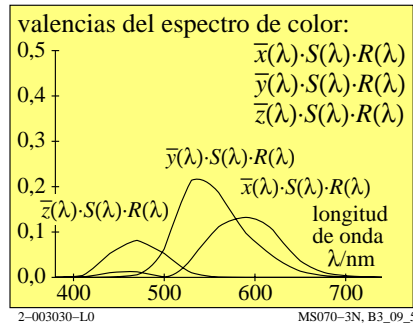
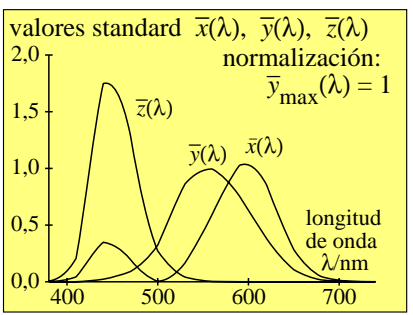
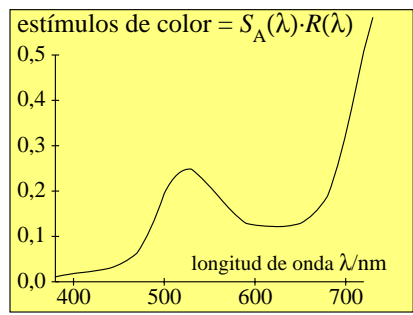

vea archivos semejantes: http://130.149.60.45/~farbmetrik/MS07/MS07.HTM
información técnica: http://www.ps.bam.de o http://130.149.60.45/~farbmetrik

TUB matrícula: 20130201-MS07/MS07LONP.PDF /.PS
aplicación para la medida de display output, ninguna separación

TUB material: code=rh4ta

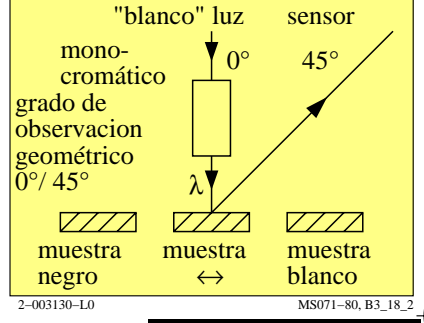
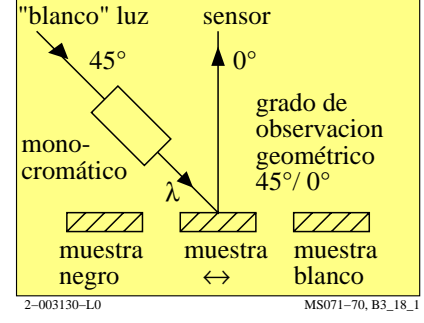
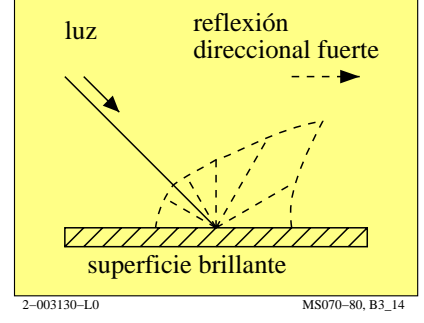
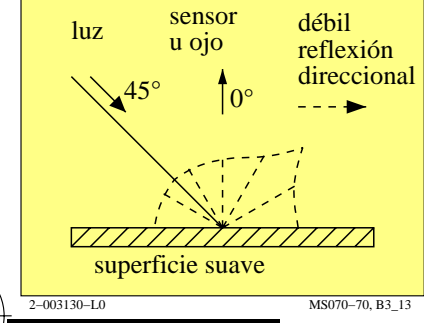
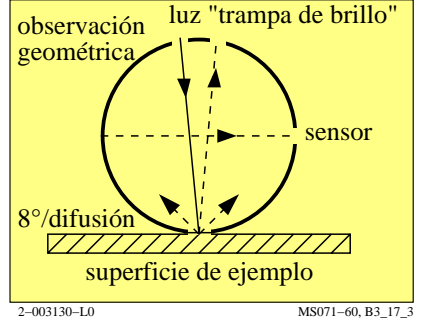
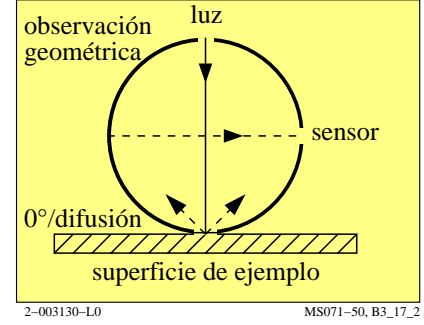
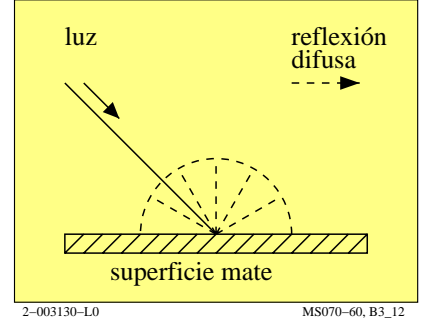
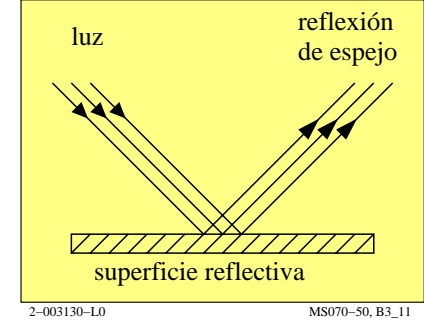
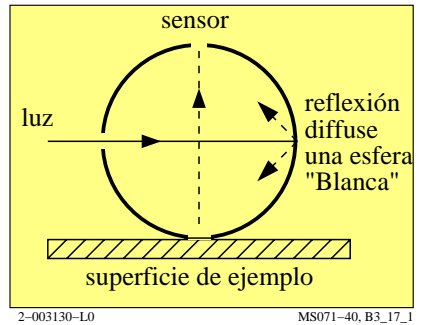
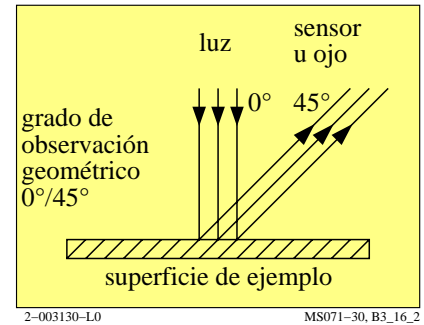
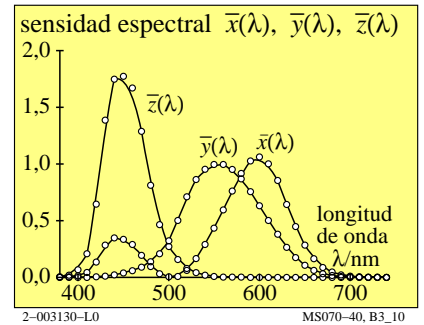
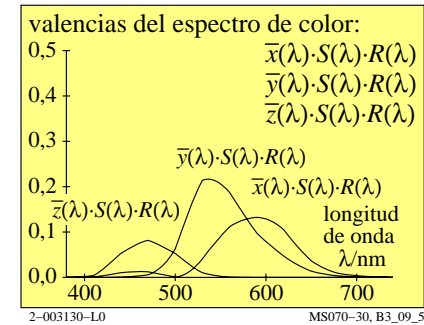
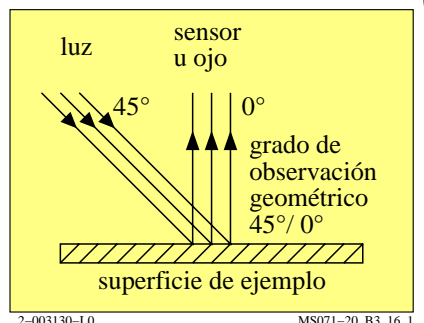
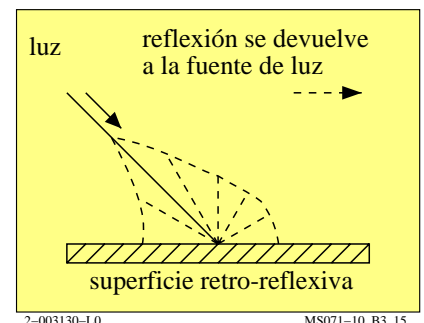
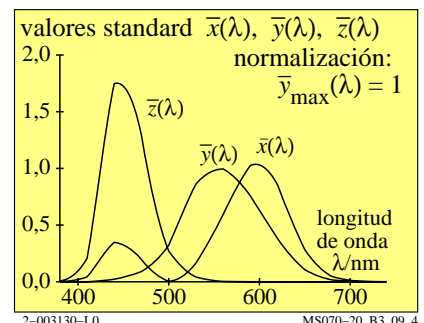
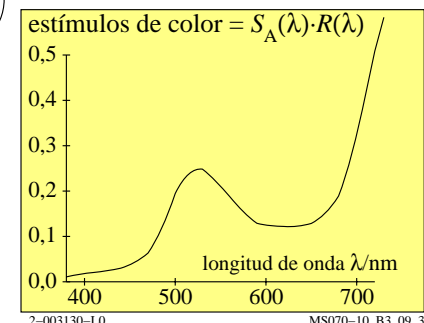

vea archivos semejantes: http://130.149.60.45/~farbmetrik/MS07/MS07.HTM información técnica: http://www.ps.bam.de o http://130.149.60.45/~farbmetrik

TUB matrícula: 20130201-MS07/MS07LONP.PDF /.PS aplicación para la medida de display output

TUB material: code=rh4ta

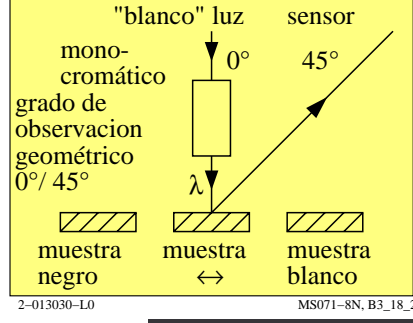
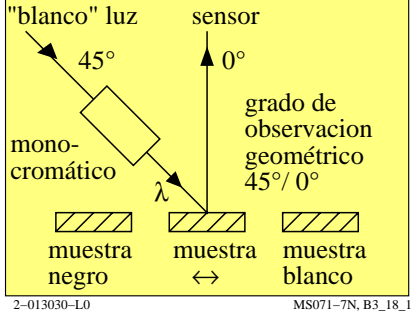
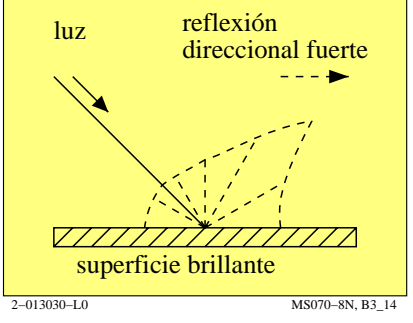
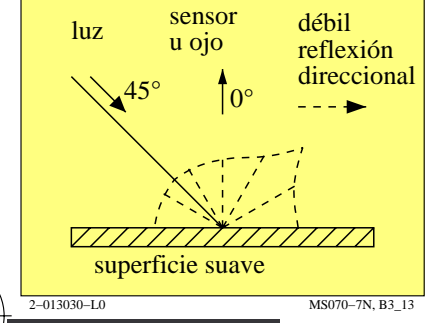
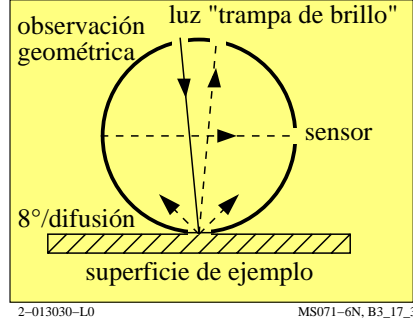
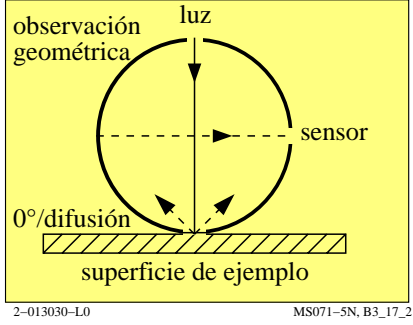
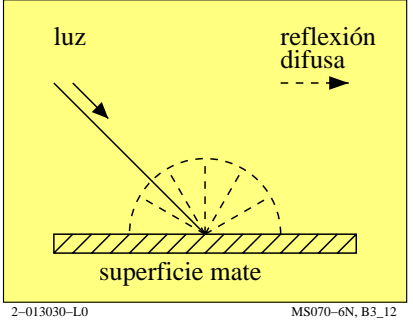
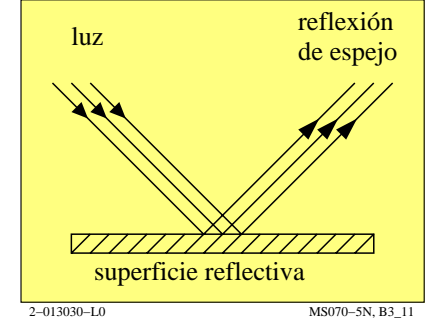
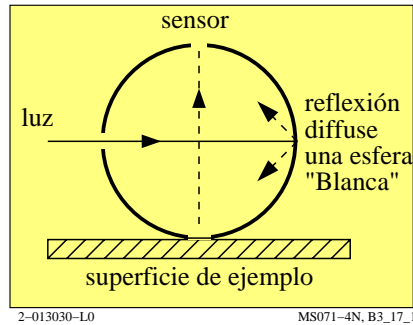
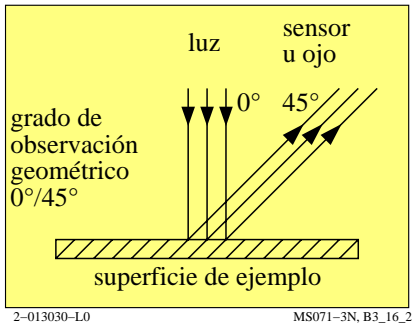
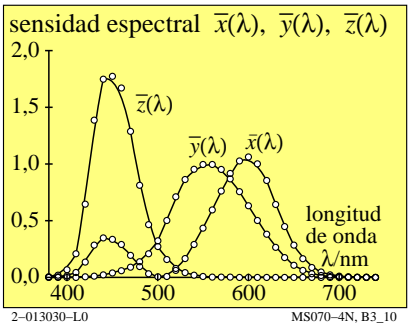
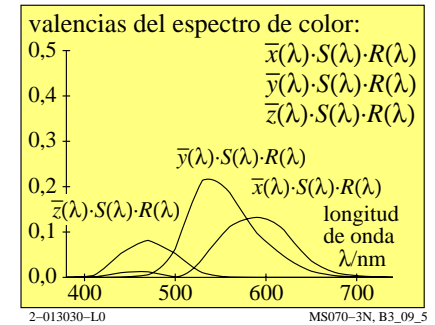
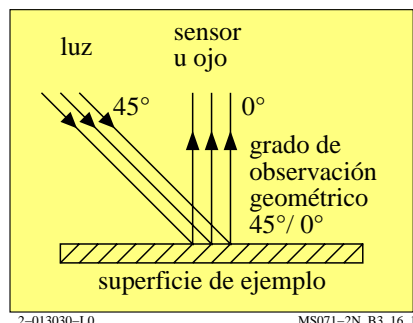
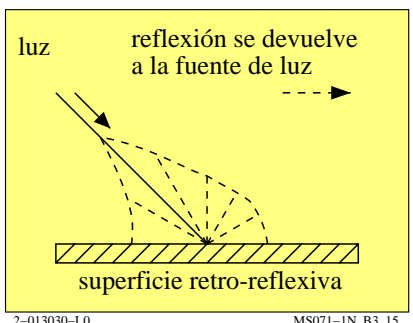
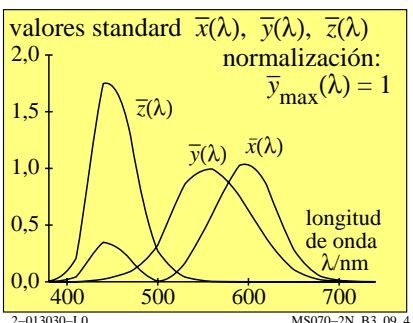
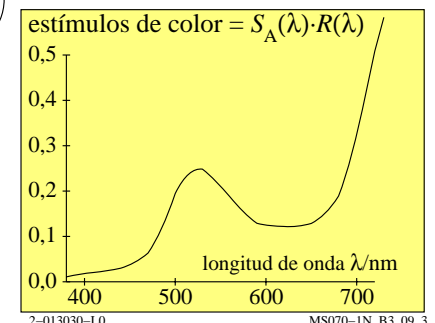

vea archivos semejantes: http://130.149.60.45/~farbmetrik/MS07/MS07.HTM información técnica: http://www.ps.bam.de o http://130.149.60.45/~farbmetrik

TUB matrícula: 20130201-MS07/MS07LONP.PDF /.PS aplicación para la medida de display output, ninguna separación TUB material: code=rh4ta

