

Picture B4: 16 visual equidistant steps of colour series *W-C*, *W-M*, *W-Y* and *W-N*

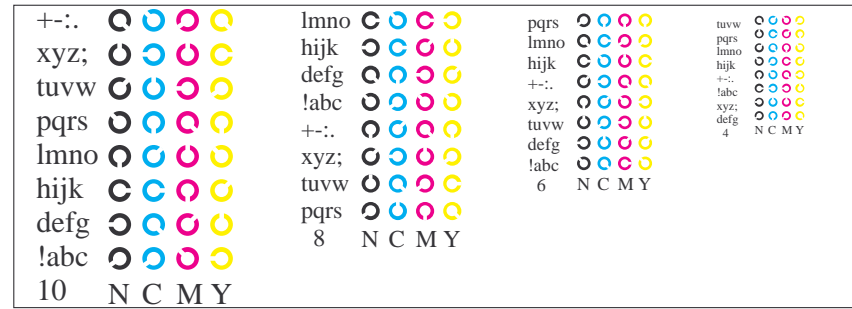

Picture B5: Script and Landolt-rings in four sizes and in colours *N*, *M*, *C* and *Y*

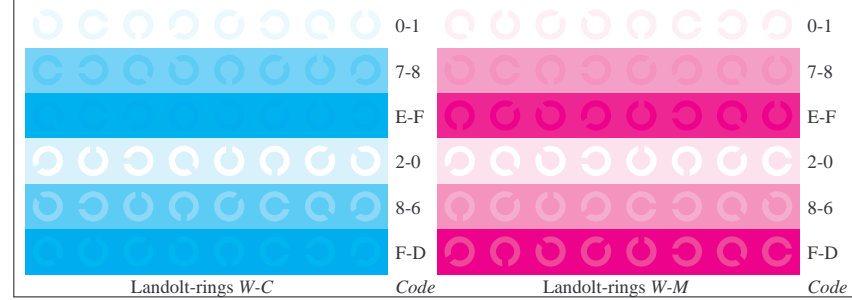

Picture B6: Landolt-rings *W-C* and *W-M*

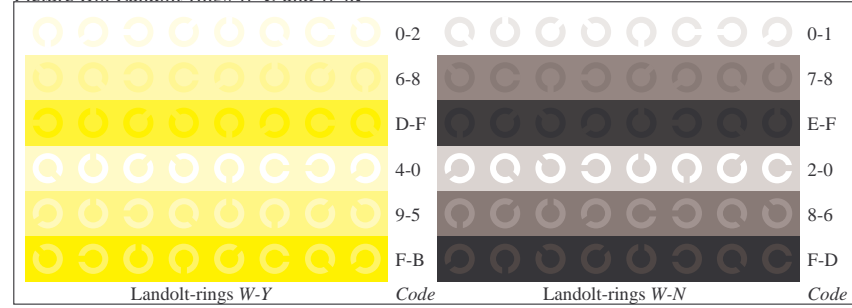

Picture B7: Landolt-rings *W-Y* and *W-N*

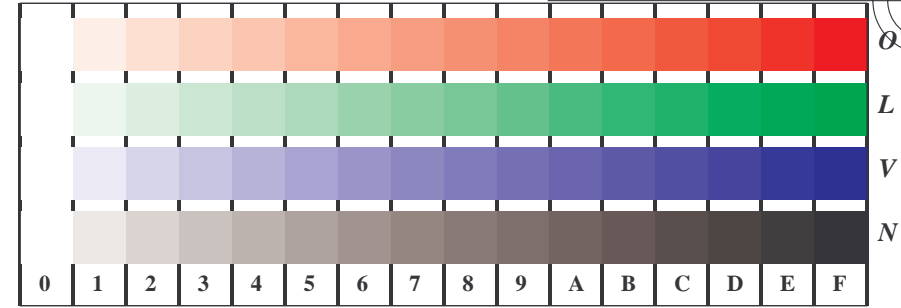

Picture D4: 16 visual equidistant steps of colour series *W-O*, *W-L*, *W-V* and *W-N*

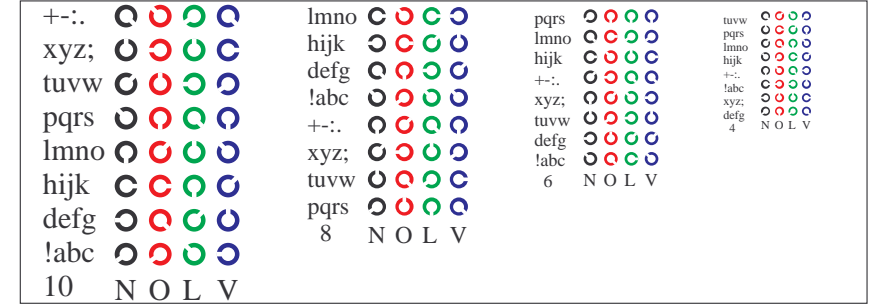

Picture D5: Script and Landolt-rings in four sizes and in colours *N*, *O*, *L* and *V*

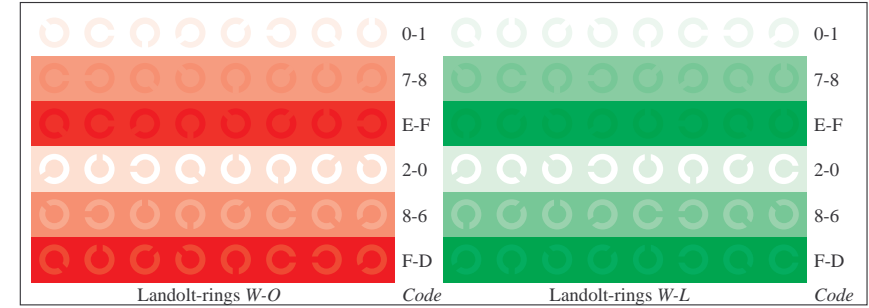

Picture D6: Landolt-rings *W-O* and *W-L*

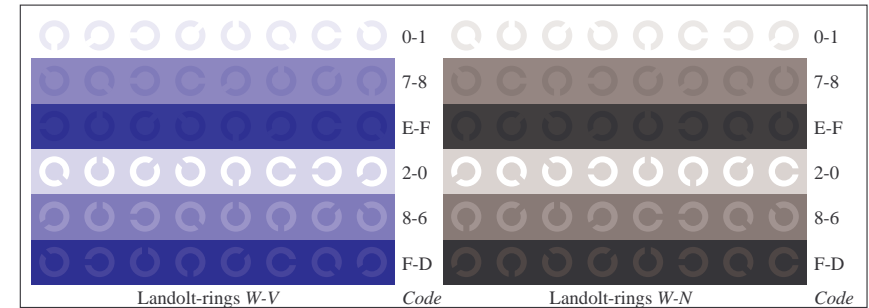

Picture D7: Landolt-rings *W-V* and *W-N*

