

See for similar files: <http://www.ps.bam.de/LE22/LE22.HTM>
 Information and Order: <http://www.ps.bam.de> Version 2.0, io=5,6; iORS; oORS, CIELAB

BAM registration: 20030101-LE22/10Q/Q22E06FP.PS/.PDF BAM material: code=tha4ta
 application for measurement of monitor (Yr=2.5) and printer output

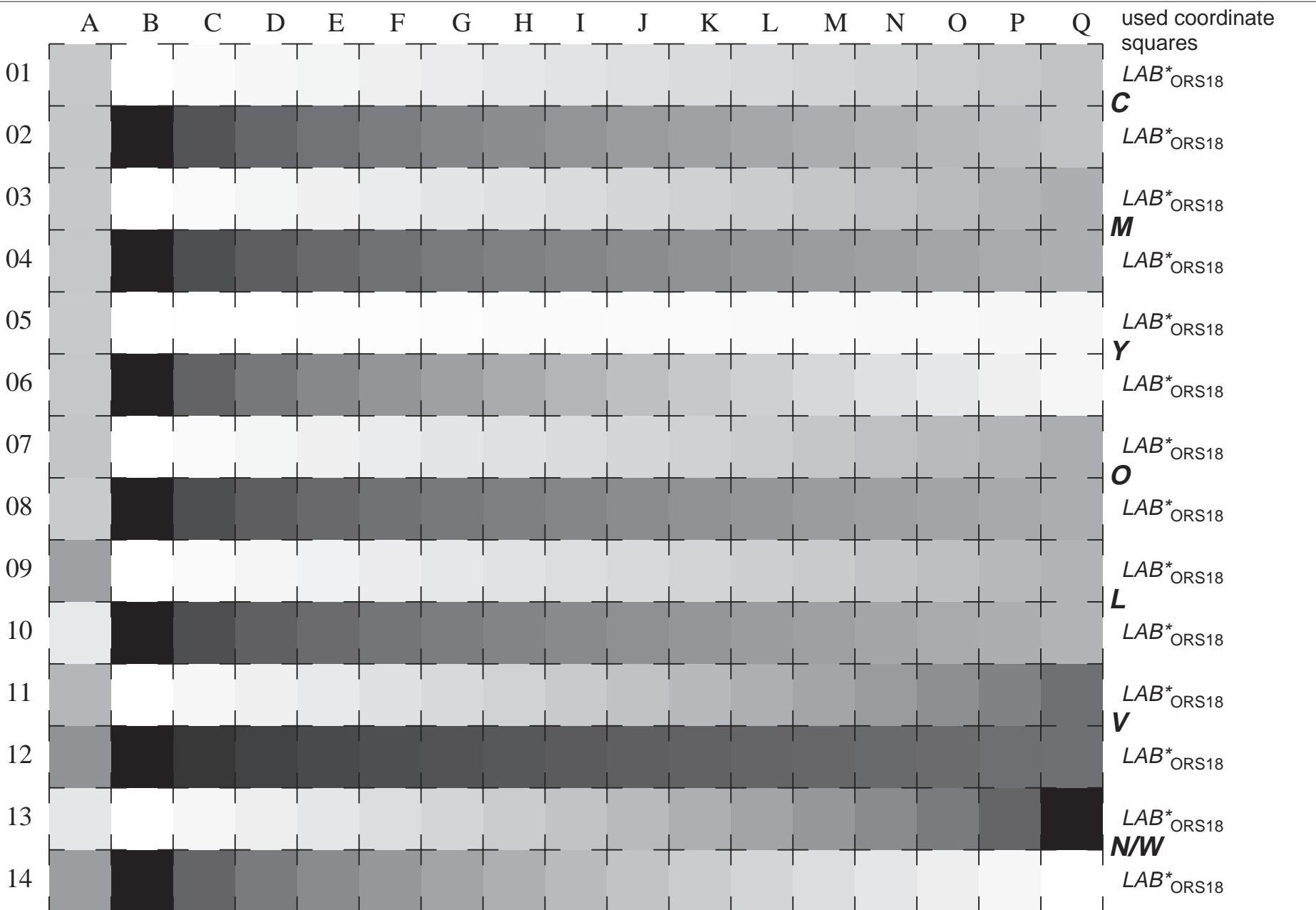

16 equidistant CIELAB steps: C-W, C-N, M-W, M-N, Y-W, Y-N, O-W, O-N, L-W, L-N, V-W, V-N, N-W, W-N and 14 CIE-test colours (left)

Test chart LE22: 16 CIELAB steps of ISO/IEC 15775 input(ORS18): LAB* setcolor
 Chromatic-White, Chromatic-Black, Black-White output(ORS18): 000n* setcmykcolor

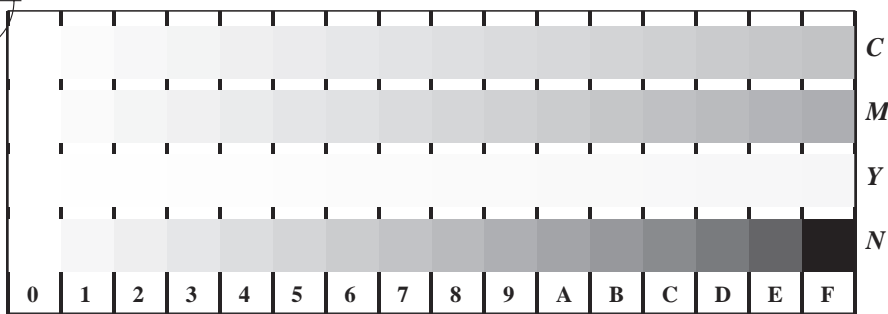

Picture D4w: 16 equidistant steps *W-C*, *W-M*, *W-Y* and *W-N*; PS operator *LAB* setcolor*

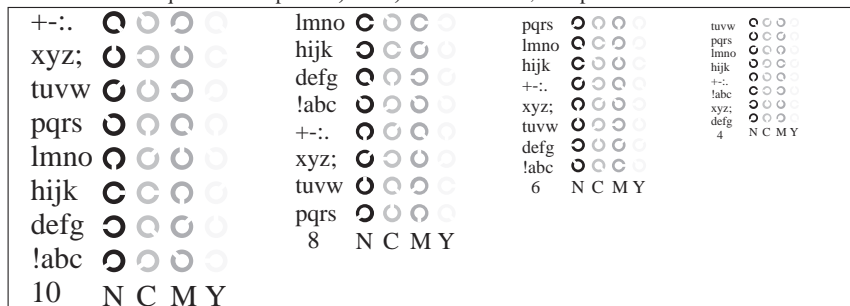

Picture B5w: Script and Landolt-rings *N*, *C*, *M* and *Y*; PS operator *LAB* setcolor*

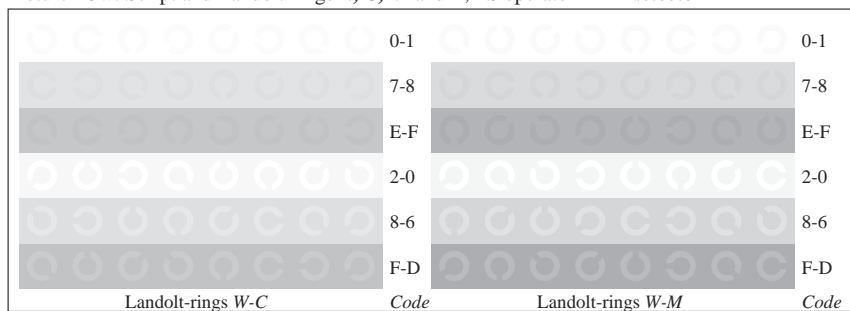

Picture B6w: Landolt-rings *W-C* and *W-M*; PS operator *LAB* setcolor*

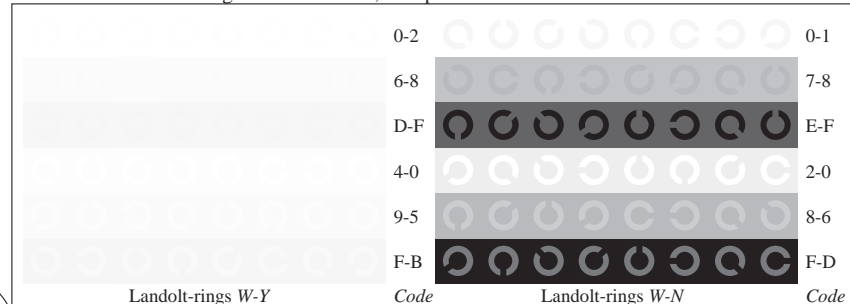

Picture B7w: Landolt-rings *W-Y* and *W-N*; PS operator *LAB* setcolor*

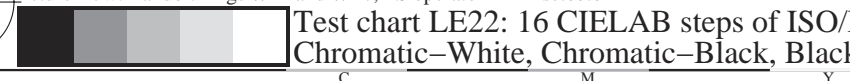

Test chart LE22: 16 CIELAB steps of ISO/IEC 15775
 Chromatic-White, Chromatic-Black, Black-White

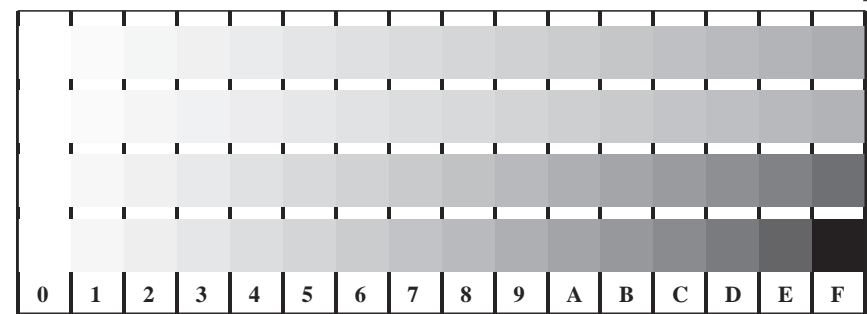

Picture D4w: 16 equidistant steps *W-O*, *W-L*, *W-V* and *W-N*; PS operator *LAB* setcolor*

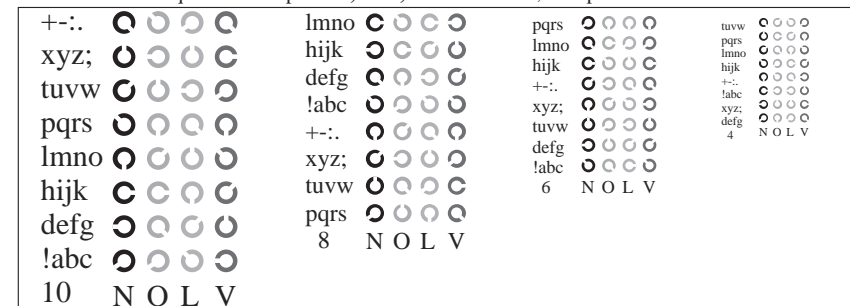

Picture D5w: Script and Landolt-rings *N*, *O*, *L* and *V*; PS operator *LAB* setcolor*

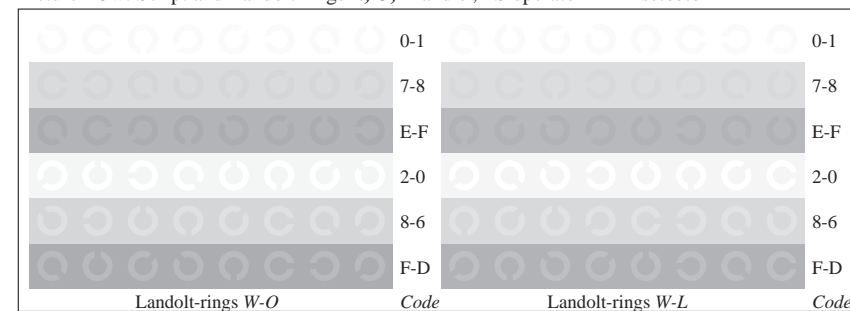

Picture D6w: Landolt-rings *W-O* and *W-L*; PS operator *LAB* setcolor*

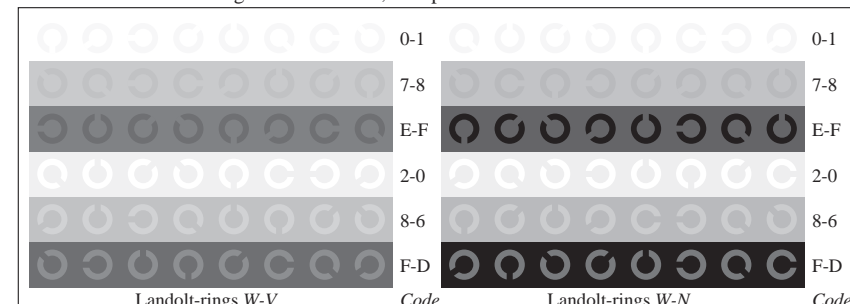

Picture D7w: Landolt-rings *W-V* and *W-N*; PS operator *LAB* setcolor*

input(ORS18): *LAB* setcolor*
 output(ORS18): *000n* setcmykcolor*

See for similar files: <http://www.ps.bam.de/LE22/LE22.HTM>
 Information and Order: <http://www.ps.bam.de>

Version 2.0, io=5,6; iORS; oORS, CIELAB

BAM registration: 20030101-LE22/10Q/Q22E16FP.PS/.PDF BAM material: code=th4ta
 application for measurement of monitor (Yr=2.5) and printer output

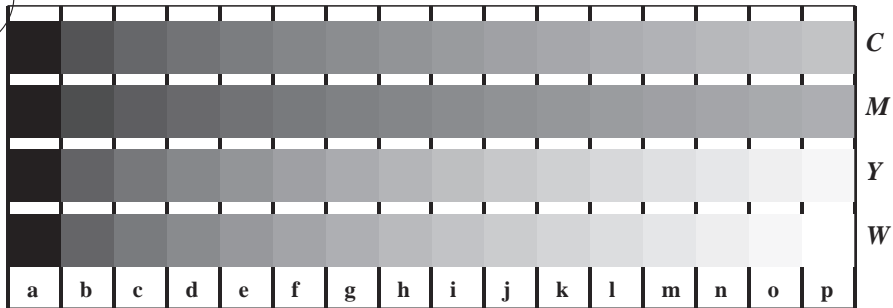

Picture B4n: 16 equidistant steps *W-C, W-M, W-Y* and *W-N*; PS operator *LAB* setcolor*

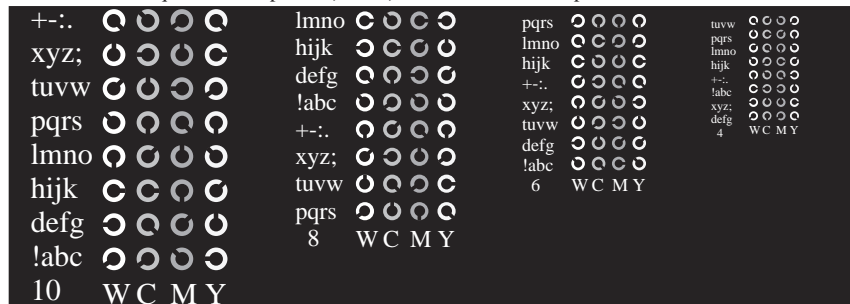

Picture D5n: Script and Landolt-rings *W, C, M* and *Y*; PS operator *LAB* setcolor*

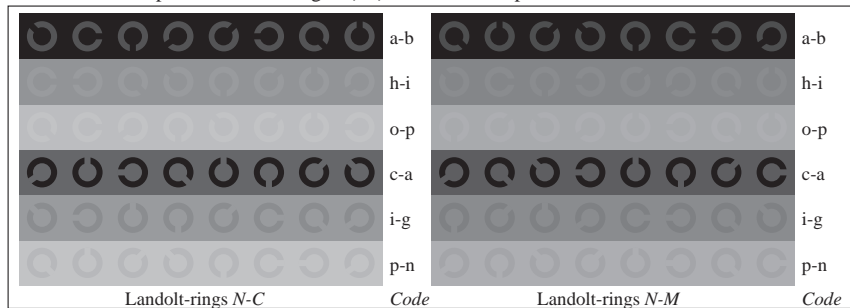

Picture B6n: Landolt-rings *N-C* and *N-M*; PS operator *LAB* setcolor*

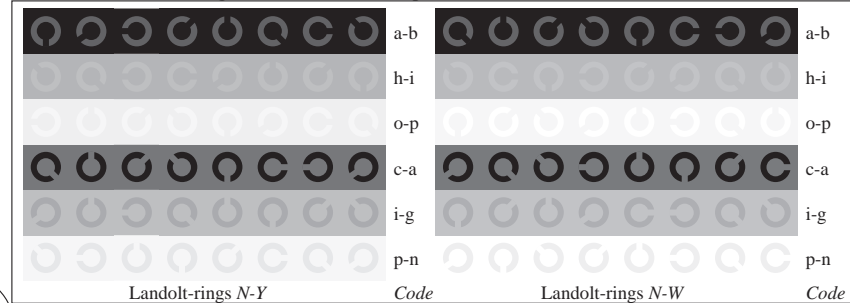

Picture B7n: Landolt-rings *W-Y* and *W-N*; PS operator *LAB* setcolor*

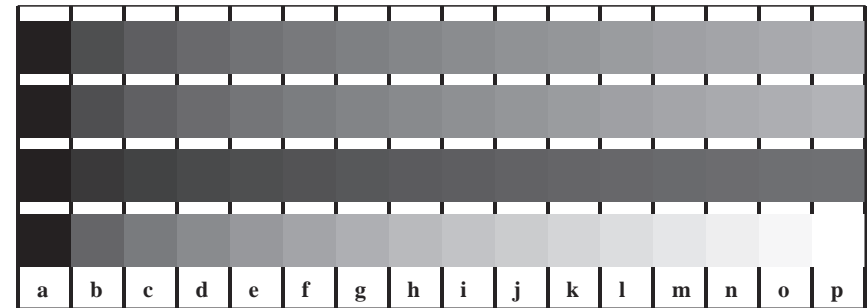

Picture D4n: 16 equidistant steps *W-O, W-L, W-V* and *W-N*; PS operator *LAB* setcolor*

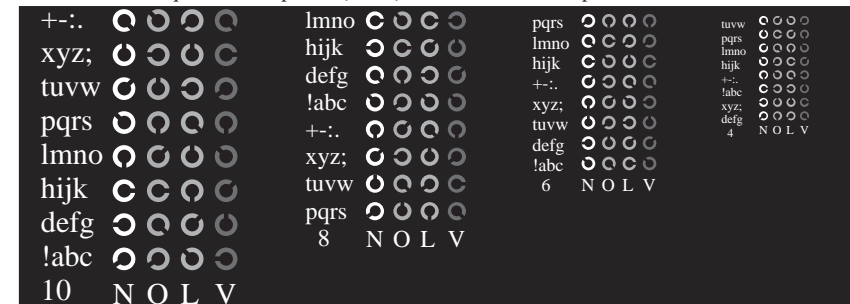

Picture D5n: Script and Landolt-rings *W, O, L* and *V*; PS operator *LAB* setcolor*

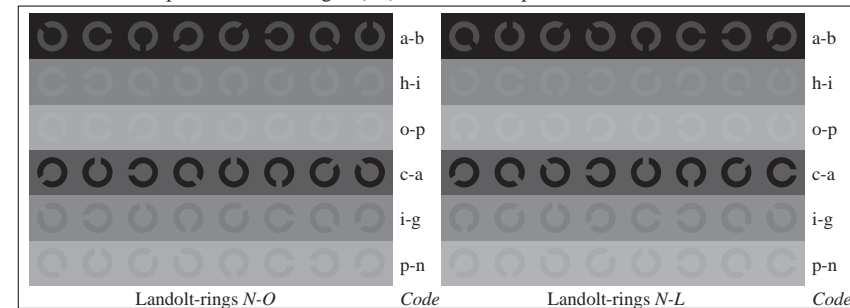

Picture D6n: Landolt-rings *N-O* and *N-L*; PS operator *LAB* setcolor*

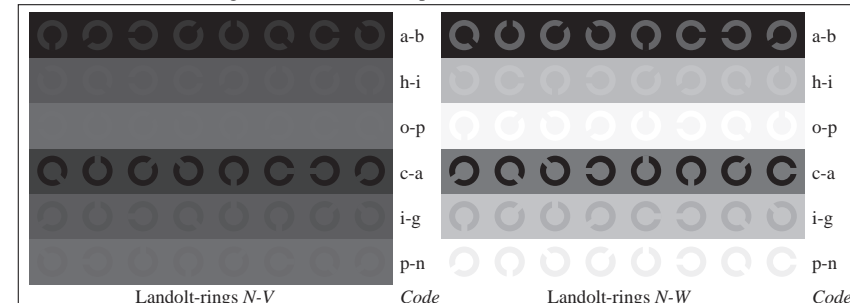

Picture D7n: Landolt-rings *N-V* and *N-N*; PS operator *LAB* setcolor*

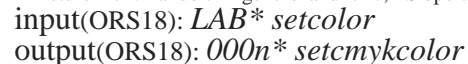

See for similar files: <http://www.ps.bam.de/LE22/LE22.HTM>
 Information and Order: <http://www.ps.bam.de>

Version 2.0, io=5,6; iORS; oORS, CIELAB

BAM registration: 20030101-LE22/10Q/Q22E26FP.PS/.PDF
 application for measurement of monitor (Yr=2.5) and printer output

BAM material: code=tha4ta

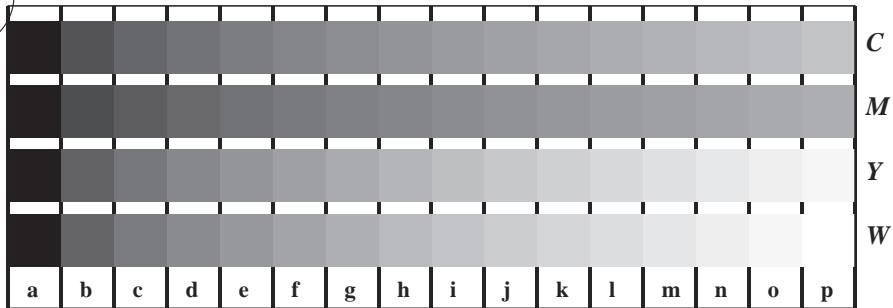

Picture B4n: 16 equidistant steps *W-C*, *W-M*, *W-Y* and *W-N*; PS operator *LAB* setcolor*

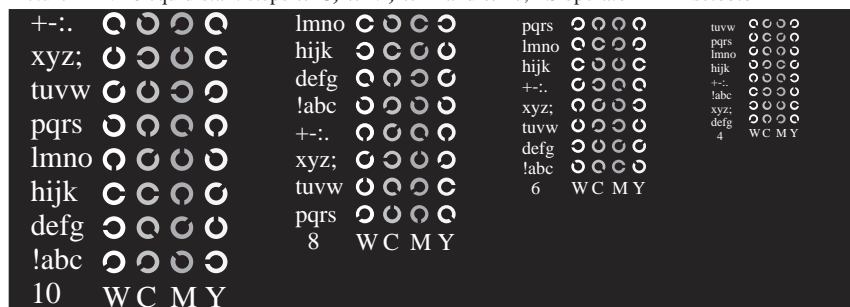

Picture D5n: Script and Landolt-rings *W*, *C*, *M* and *Y*; PS operator *LAB* setcolor*

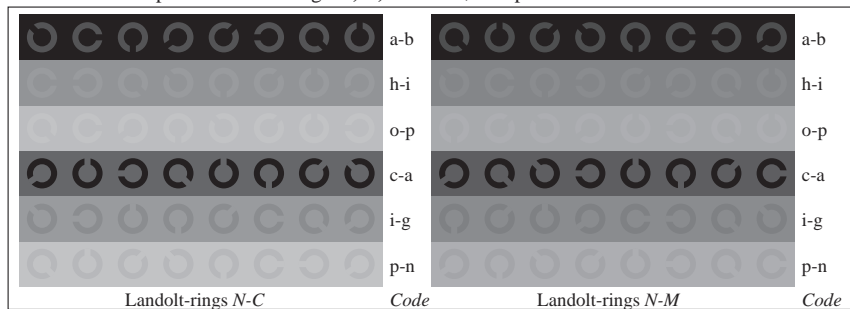

Picture B6n: Landolt-rings *N-C* and *N-M*; PS operator *LAB* setcolor*

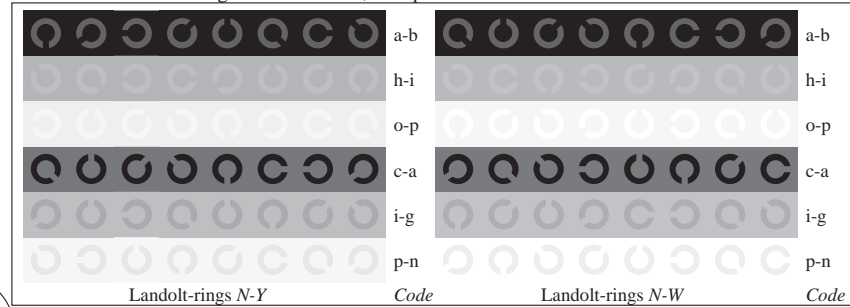

Picture B7n: Landolt-rings *W-Y* and *W-N*; PS operator *LAB* setcolor*



Test chart LE22: 16 CIELAB steps of ISO/IEC 15775
 Chromatic-White, Chromatic-Black, Black-White

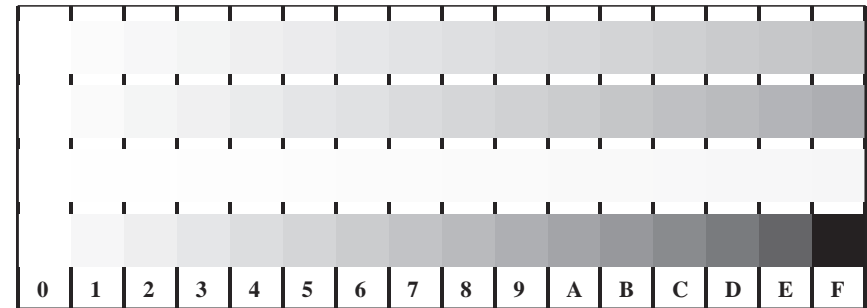

Picture D4w: 16 equidistant steps *W-C*, *W-M*, *W-Y* and *W-N*; PS operator *LAB* setcolor*

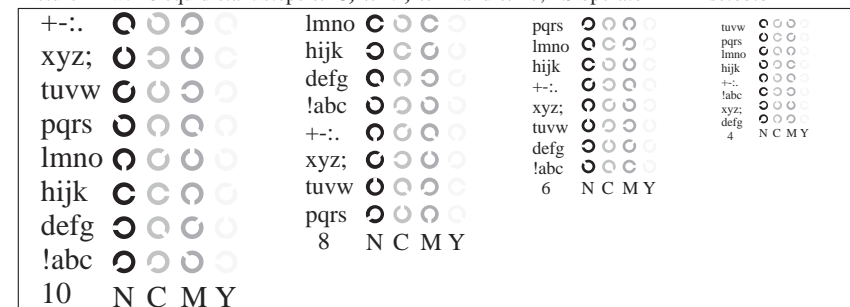

Picture B5w: Script and Landolt-rings *N*, *C*, *M* and *Y*; PS operator *LAB* setcolor*

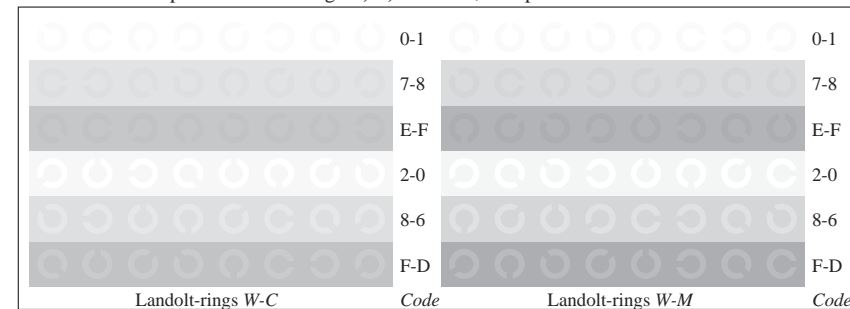

Picture B6w: Landolt-rings *W-C* and *W-M*; PS operator *LAB* setcolor*

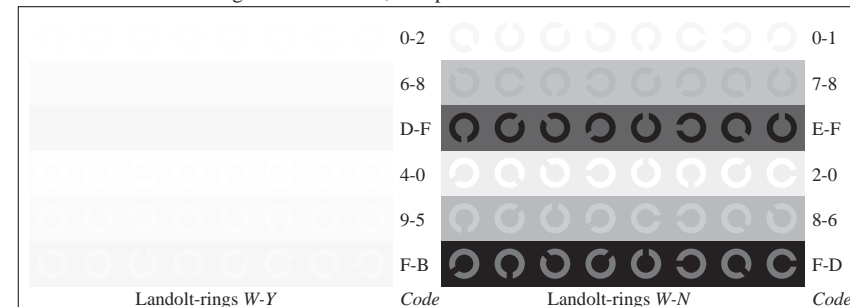

Picture B7w: Landolt-rings *W-Y* and *W-N*; PS operator *LAB* setcolor*

input(ORS18): *LAB* setcolor*
 output(ORS18): *000n* setcmykcolor*

See for similar files: <http://www.ps.bam.de/LE22/LE22.HTM>
 Information and Order: <http://www.ps.bam.de>

Version 2.0, io=5,6; iORS; oORS, CIELAB

BAM registration: 20030101-LE22/10Q/Q22E36FP.PS/.PDF BAM material: code=th4ta
 application for measurement of monitor (Yr=2.5) and printer output

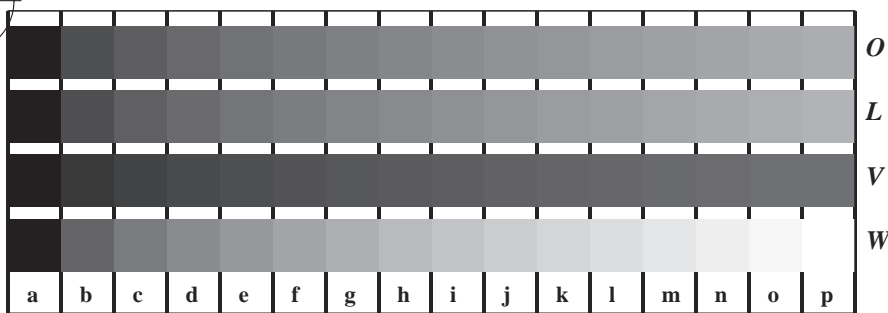

Picture D4n: 16 equidistant steps *W-O*, *W-L*, *W-V* and *W-N*; PS operator *LAB* setcolor*

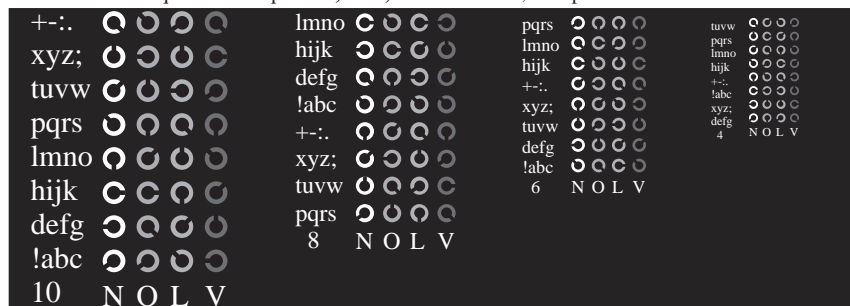

Picture D5n: Script and Landolt-rings *W*, *O*, *L* and *V*; PS operator *LAB* setcolor*

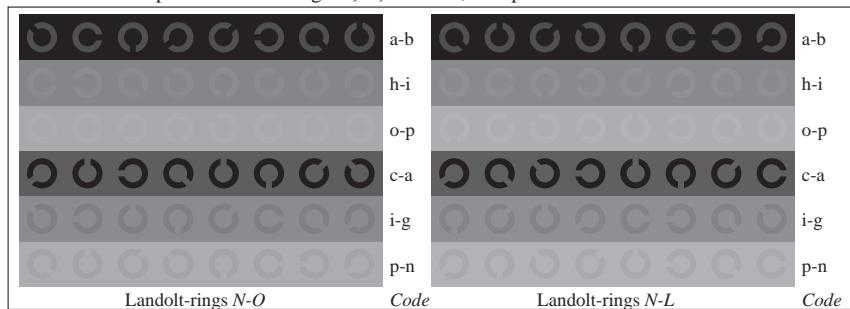

Picture D6n: Landolt-rings *N-O* and *N-L*; PS operator *LAB* setcolor*

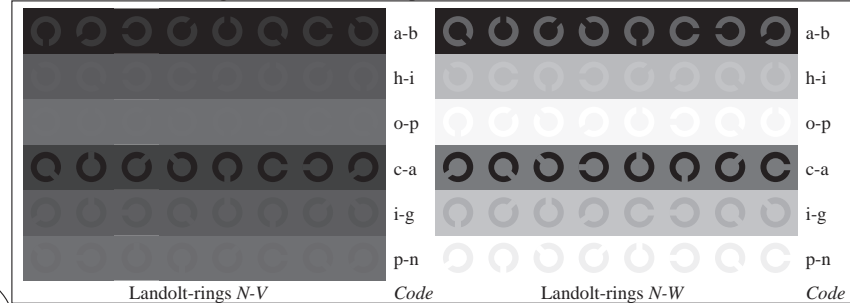

Picture D7n: Landolt-rings *N-V* and *N-N*; PS operator *LAB* setcolor*

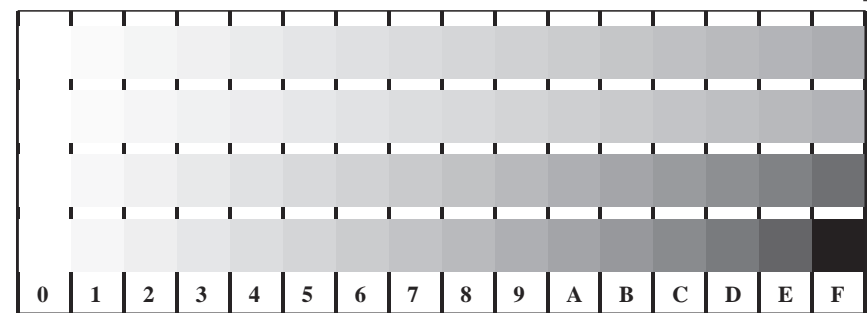

Picture D4w: 16 equidistant steps *W-O*, *W-L*, *W-V* and *W-N*; PS operator *LAB* setcolor*

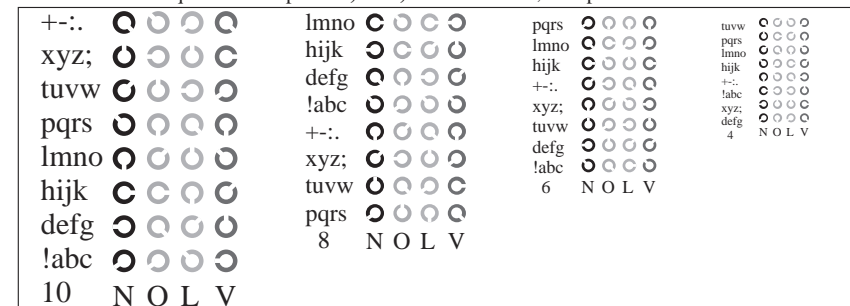

Picture D5w: Script and Landolt-rings *N*, *O*, *L* and *V*; PS operator *LAB* setcolor*

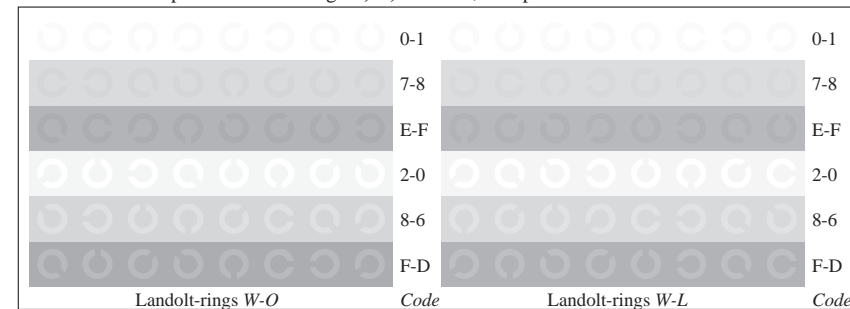

Picture D6w: Landolt-rings *W-O* and *W-L*; PS operator *LAB* setcolor*

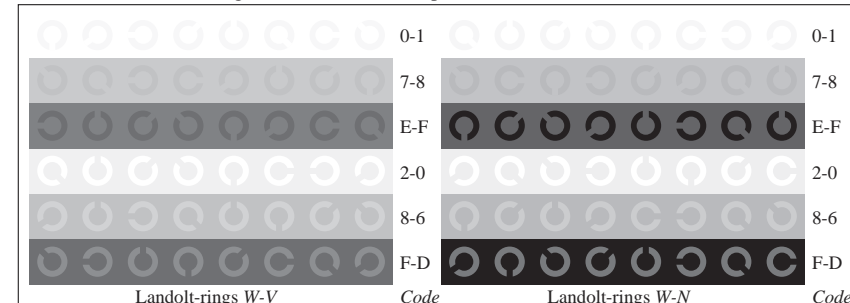

Picture D7w: Landolt-rings *W-V* and *W-N*; PS operator *LAB* setcolor*

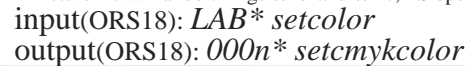

See for similar files: <http://www.ps.bam.de/LE22/LE22.HTM>
 Information and Order: <http://www.ps.bam.de>

Version 2.0, io=5,6; iORS; oORS, CIELAB

BAM registration: 20030101-LE22/10Q/Q22E46FP.PS/.PDF
 application for measurement of monitor (Yr=2.5) and printer output

BAM material: code=th4ta