

vedi file simili: http://farbe.li.tu-berlin.de/MI06/MI06.HTM
http://130.149.60.45/~farbmertik o http://farbe.li.tu-berlin.de

iscrizione TUB: 20160501-MI06/MI06L0FP.PDF /.PS
Applicazione per la misura dell'output su display

TUB materiale: code=rh4ta

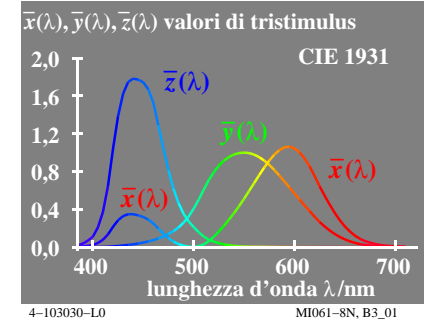
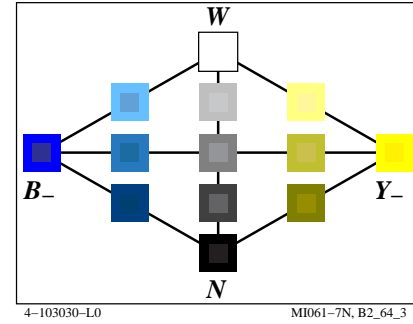
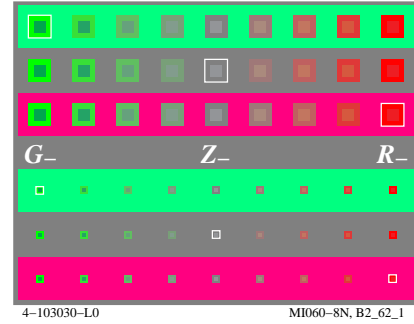
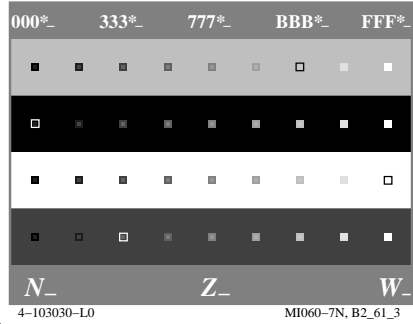
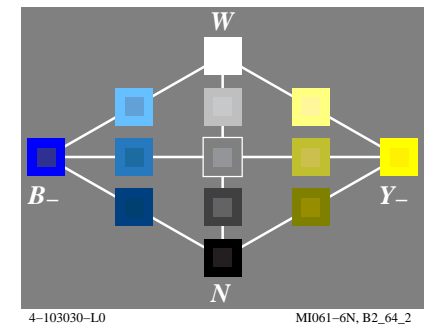
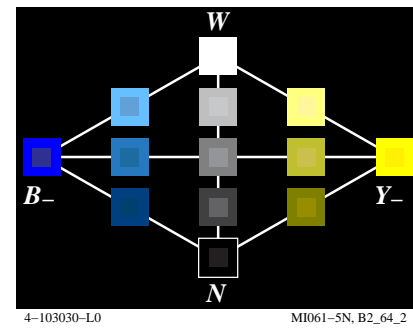
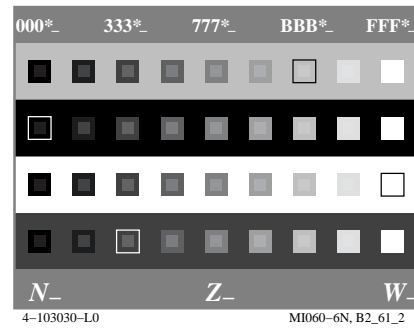
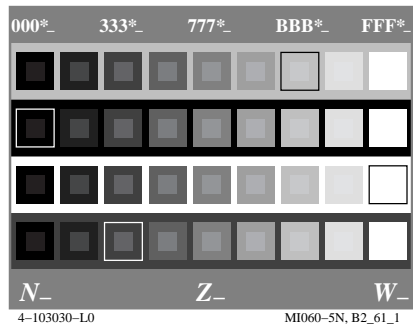
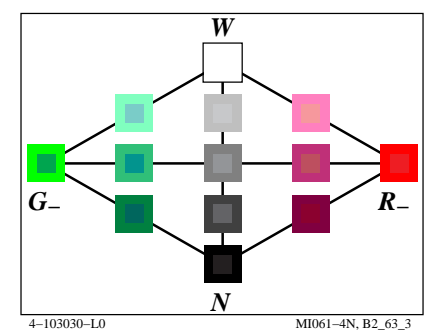
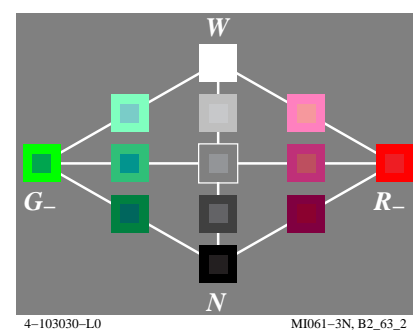
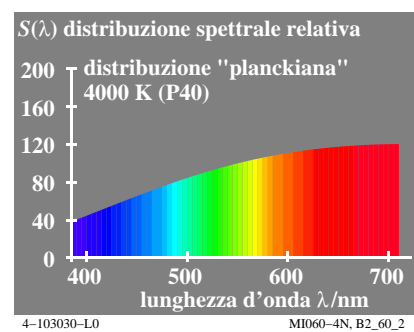
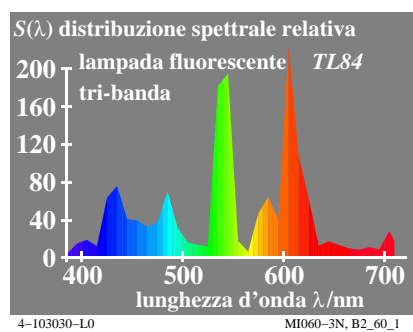
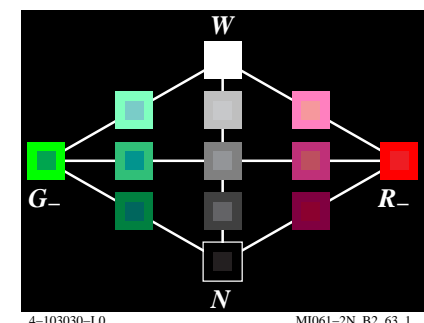
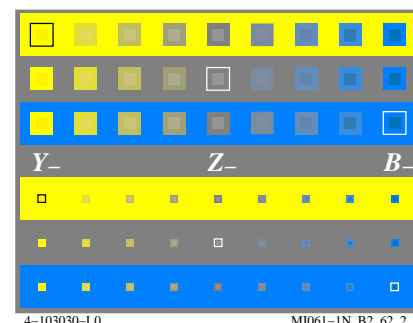
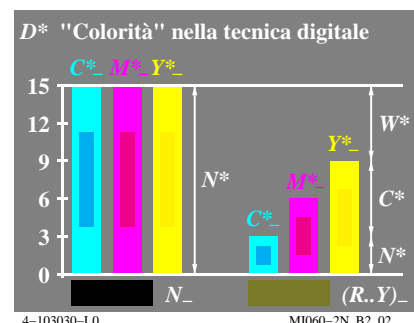
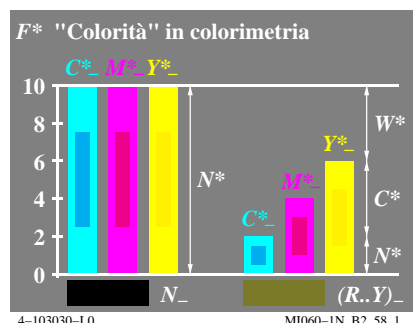

vedi file simili: <http://farbe.li.tu-berlin.de/MI06/MI06.HTM>
<http://130.149.60.45/~farbmertik> o <http://farbe.li.tu-berlin.de>

iscrizione TUB: 20160501-MI06/MI06L0FP.PDF /.PS
Applicazione per la misura dell'output su display, nessuna separazione
TUB materiale: code=rh4ta

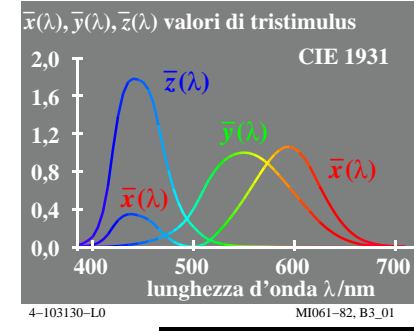
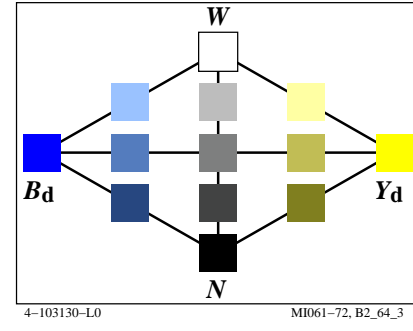
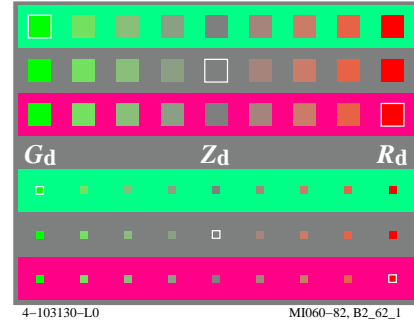
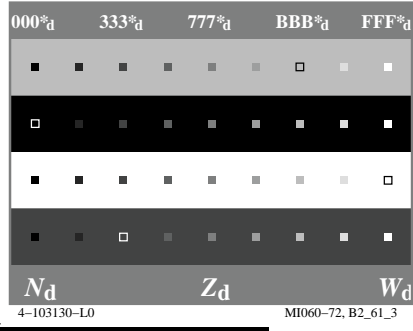
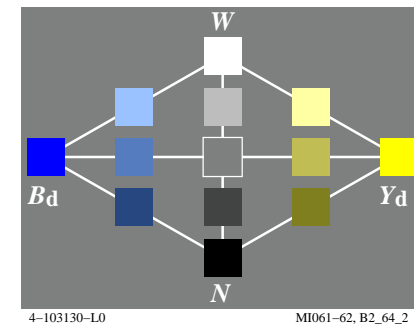
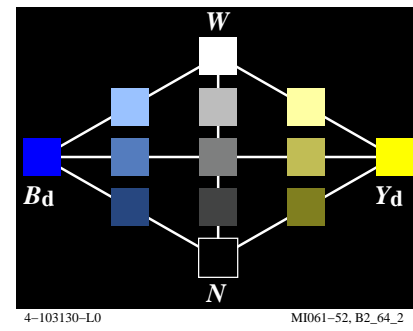
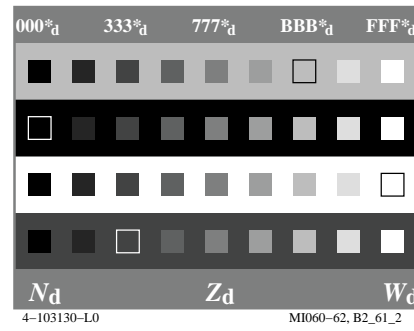
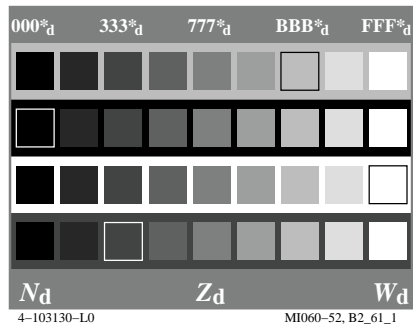
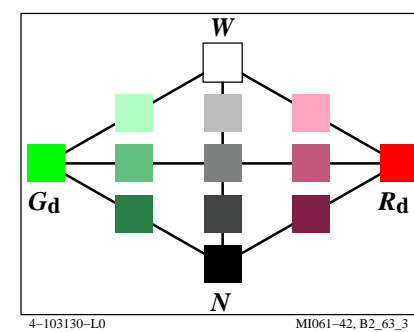
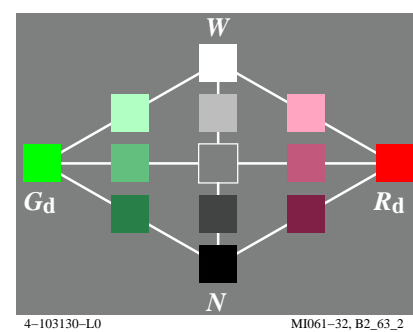
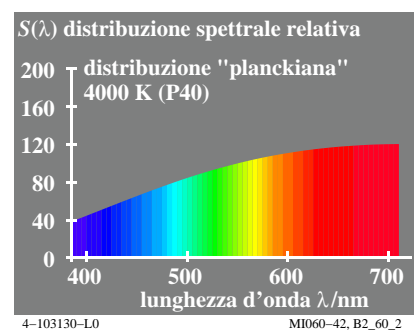
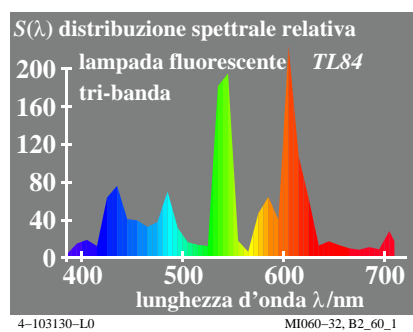
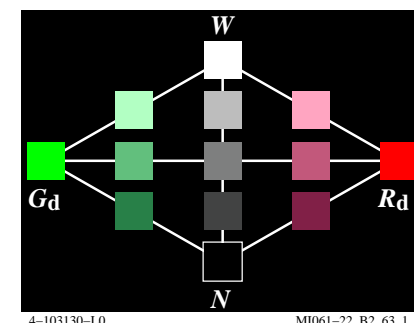
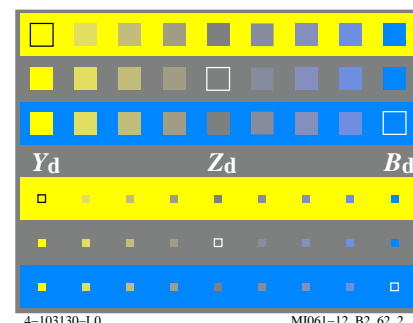
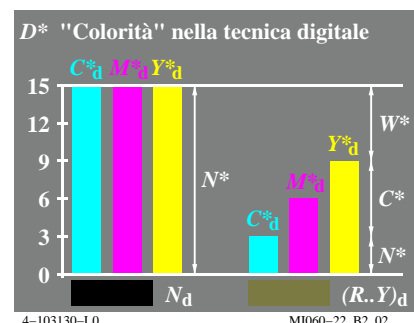
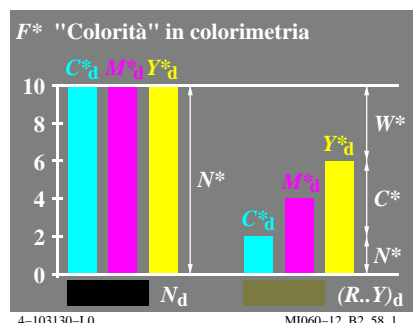

vedi file simili: http://farbe.li.tu-berlin.de/MI06/MI06.HTM
http://130.149.60.45/~farbmatrik o http://farbe.li.tu-berlin.de

iscrizione TUB: 20160501-MI06/MI06L0FP.PDF /.PS
Applicazione per la misura dell'output su display

TUB materiale: code=rh4ta

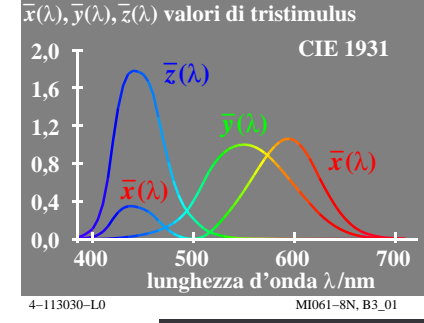
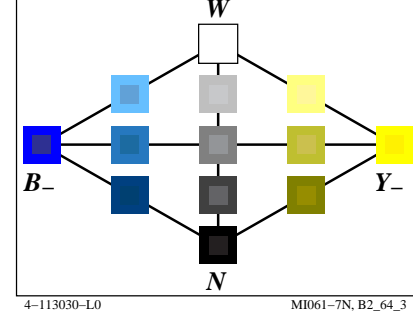
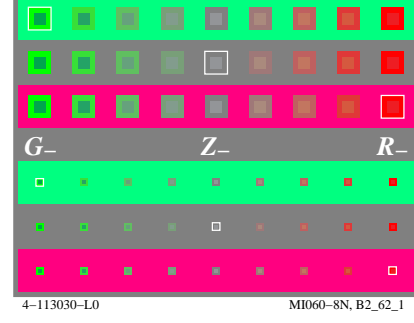
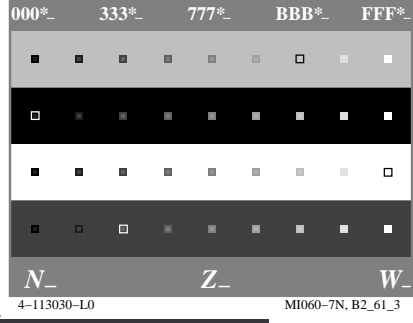
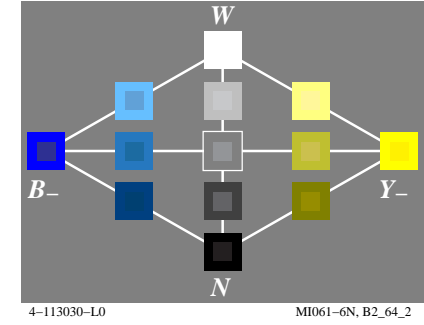
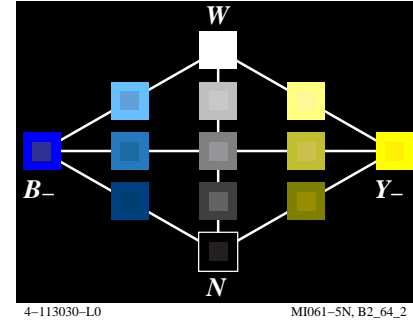
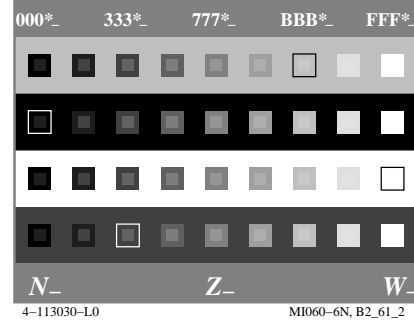
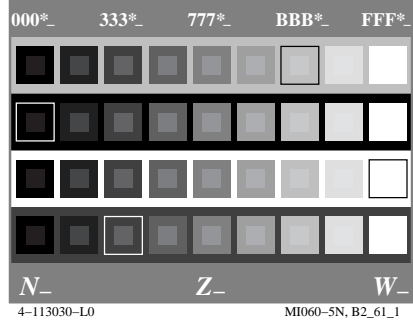
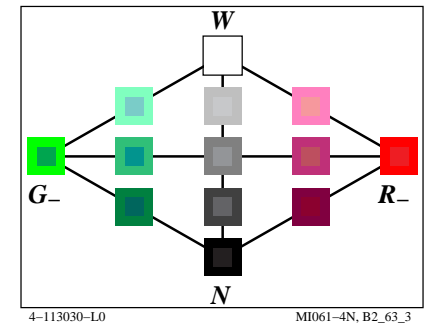
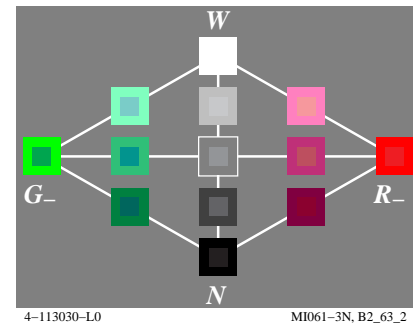
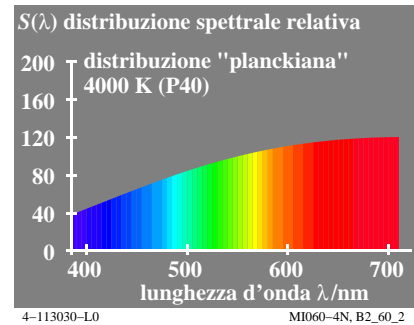
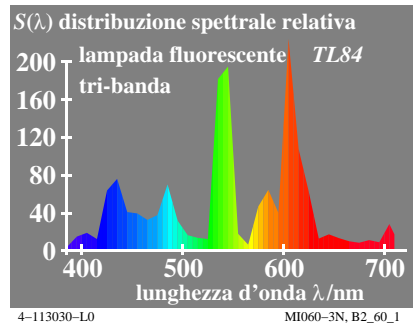
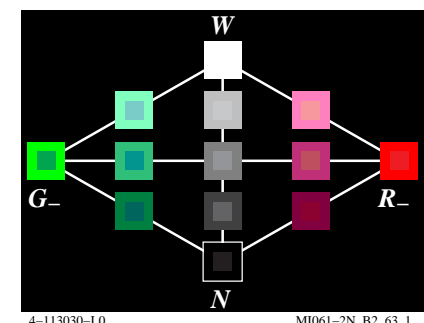
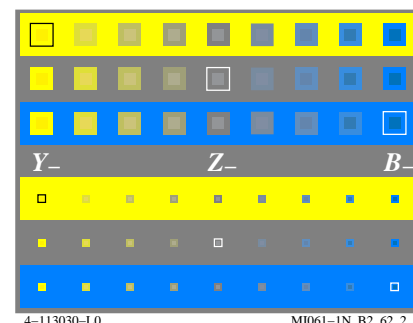
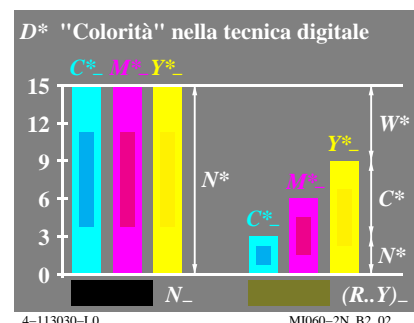
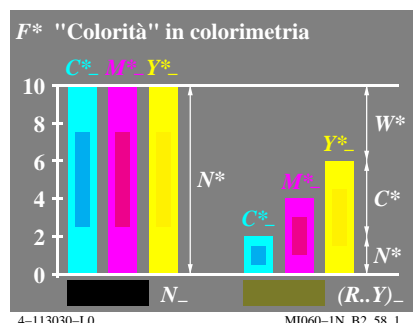

vedi file simili: <http://farbe.li.tu-berlin.de/MI06/MI06.HTM>
<http://130.149.60.45/~farbmatrik> o <http://farbe.li.tu-berlin.de>

iscrizione TUB: 20160501-MI06/MI06L0FP.PDF /.PS
Applicazione per la misura dell'output su display, nessuna separazione
TUB materiale: code=rh4ta

